

# Operating Instructions

## T82

### Dual-Input Temperature Head Transmitter

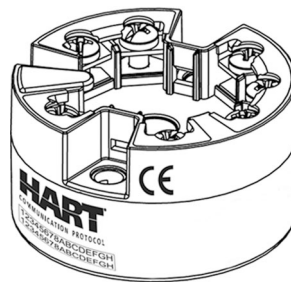

## Brief overview

*For quick and straightforward commissioning:*

<b>Safety instructions</b>	(→ 6)
▼	
<b>Installation instructions</b>	(→ 8)
▼	
<b>Wiring</b>	(→ 13)
▼	
<b>Display and operating elements</b>	(→ 17)
▼	
<b>Commissioning</b>	(→ 25)
Commissioning using the HART®-protocol interface - quick start for device configuration for standard operation	
<b>Customer-specific configuration</b>	(→ 41)

Complex measurement tasks require additional functions to be configured that the user can individually select, set and adapt to his process conditions by setting the appropriate parameters. A detailed description of all the functions and device parameters.

## Table of contents

<b>1</b>	<b>Important document information</b> . . . . .	<b>4</b>	<b>11</b>	<b>Diagnostics and troubleshooting</b> . . . . .	<b>27</b>
1.1	About this document . . . . .	4	11.1	Troubleshooting . . . . .	27
1.2	Document conventions . . . . .	4	11.2	Diagnostics events . . . . .	29
<b>2</b>	<b>Basic safety instructions</b> . . . . .	<b>6</b>	11.3	Spare parts . . . . .	32
2.1	Requirements for the personnel . . . . .	6	11.4	Return . . . . .	32
2.2	Designated use . . . . .	6	11.5	Disposal . . . . .	32
2.3	Operational safety . . . . .	6	11.6	Software history and overview of compatibility . . . . .	32
<b>3</b>	<b>Identification</b> . . . . .	<b>7</b>	<b>12</b>	<b>Technical data</b> . . . . .	<b>33</b>
3.1	Nameplate . . . . .	7	<b>13</b>	<b>Operating menu and parameter description</b> . . . . .	<b>41</b>
3.2	Scope of delivery . . . . .	7	13.1	"Display/operation" menu . . . . .	47
3.3	Certificates and approvals . . . . .	7	13.2	"Setup" menu . . . . .	51
<b>4</b>	<b>Installation instructions</b> . . . . .	<b>8</b>	13.3	"Diagnostics" menu . . . . .	62
4.1	Incoming acceptance, transport, storage . . . . .	8	13.4	"Expert" menu . . . . .	70
4.2	Installation conditions . . . . .	8	<b>Index</b> . . . . .	<b>86</b>	
4.3	Installation instructions . . . . .	8			
4.4	Post-installation check . . . . .	12			
<b>5</b>	<b>Wiring</b> . . . . .	<b>13</b>			
5.1	Quick wiring guide . . . . .	13			
5.2	Connecting the sensor cables . . . . .	14			
5.3	Connecting the power supply and signal cables . . . . .	14			
5.4	Shielding and grounding . . . . .	15			
5.5	Post-connection check . . . . .	16			
<b>6</b>	<b>Operating options</b> . . . . .	<b>17</b>			
6.1	Overview of operation options . . . . .	17			
6.2	Structure and function of the operating menu . . . . .	18			
6.3	Measured value display and operating elements . . . . .	20			
6.4	Access to the operating menu via the operating tool . . . . .	21			
<b>7</b>	<b>Integrating the transmitter via the HART® protocol</b> . . . . .	<b>23</b>			
7.1	HART device variables and measured values . . . . .	23			
7.2	Device variables and measured values . . . . .	23			
<b>8</b>	<b>Commissioning</b> . . . . .	<b>25</b>			
8.1	Function check . . . . .	25			
8.2	Switching on the transmitter . . . . .	25			
8.3	Enabling configuration . . . . .	25			
<b>9</b>	<b>Maintenance</b> . . . . .	<b>25</b>			
<b>10</b>	<b>Accessories</b> . . . . .	<b>26</b>			

# 1 Important document information

## 1.1 About this document

### 1.1.1 Document function



These Operating Instructions contain all the information that is required in various phases of the life cycle of the device: from product identification, incoming acceptance and storage, to mounting, connection, operation and commissioning through to troubleshooting, maintenance and disposal.

### 1.1.2 Safety Instructions





When using in hazardous areas, the national safety requirements must be met. Separate Ex documentation is contained in these Operating Instructions for measurement systems that are to be mounted in hazardous areas. Strict compliance with the installation instructions, ratings and safety instructions as listed in this supplementary documentation is mandatory. Ensure you are using the correct Ex documentation for the relevant Ex-approved device.

## 1.2 Document conventions









### 1.2.1 Safety symbols

Symbol	Meaning
 A0011189-EN	<b>DANGER!</b> This symbol alerts you to a dangerous situation. Failure to avoid this situation will result in serious or fatal injury.
 A0011191-EN	<b>CAUTION!</b> This symbol alerts you to a dangerous situation. Failure to avoid this situation can result in minor or medium injury.
 A0011192-EN	<b>NOTE!</b> This symbol contains information on procedures and other facts which do not result in personal injury.



### 1.2.2 Electrical symbols

Symbol	Meaning
 A0011197	<b>Direct current</b> A terminal to which DC voltage is applied or through which direct current flows.
 A0011198	<b>Alternating current</b> A terminal to which alternating voltage (sine-wave) is applied or through which alternating current flows.
 A0011200	<b>Ground connection</b> A grounded terminal which, as far as the operator is concerned, is grounded via a grounding system.
 A0011199	<b>Protective ground connection</b> A terminal which must be connected to ground prior to establishing any other connections.
 A0011201	<b>Equipotential connection</b> A connection that has to be connected to the plant grounding system: This may be a potential equalization line or a star grounding system depending on national or company codes of practice.

### 1.2.3 Symbols and notation for certain types of information

Symbol	Meaning
 A0011182	<b>Allowed</b> Indicates procedures, processes or actions that are allowed.
 A0011183	<b>Preferred</b> Indicates procedures, processes or actions that are preferred.
 A0011184	<b>Forbidden</b> Indicates procedures, processes or actions that are forbidden.
 A0011193	<b>Tip</b> Indicates additional information.
 A0011194	<b>Reference to documentation</b> Refers to the corresponding device documentation.
 A0011195	<b>Reference to page</b> Refers to the corresponding page number.
 A0011196	<b>Reference to graphic</b> Refers to the corresponding graphic number and page number.
<b>1., 2., 3.</b>	<b>Series of steps</b>
	<b>Result of a sequence of actions</b>

### 1.2.4 Symbols and notation in graphics

Symbol	Meaning
<b>1,2,3 ...</b>	Item numbers
<b>A, B, C, ...</b>	Views
<b>A-A, B-B, C-C, ...</b>	Sections
 A0011187	<b>Hazardous area</b> Indicates a hazardous area.
 A0011188	<b>Safe area (non-hazardous area)</b> Indicates a non-hazardous area.

## 2 Basic safety instructions

### 2.1 Requirements for the personnel

The personnel for installation, commissioning, diagnostics and maintenance must fulfill the following requirements:

- ▶ Trained, qualified specialists must have a relevant qualification for this specific function and task
- ▶ Are authorized by the plant owner/operator
- ▶ Are familiar with federal/national regulations
- ▶ Before beginning work, the specialist staff must have read and understood the instructions in the Operating Instructions and supplementary documentation as well as in the certificates (depending on the application)
- ▶ Following instructions and basic conditions

The operating personnel must fulfill the following requirements:

- ▶ Being instructed and authorized according to the requirements of the task by the facility's owner-operator
- ▶ Following the instructions in these Operating Instructions

### 2.2 Designated use

The device is a universal and user-configurable temperature head transmitter with either one or two sensor inputs for a resistance thermometer (RTD), thermocouples (TC) or resistance and voltage transmitters. The device is designed for mounting in a flat-face terminal head as per DIN 43729. Installation on a DIN rail with the optional available DIN rail clip is also possible.

The manufacturer is not liable for damage caused by improper or non-designated use.

### 2.3 Operational safety

- ▶ Operate the device in proper technical condition and fail-safe condition only.
- ▶ The operator is responsible for interference-free operation of the device.

#### **Hazardous area**

To eliminate a danger for persons or for the facility when the device is used in the hazardous area (e.g. explosion protection):

- ▶ Based on the technical data on the nameplate, check whether the ordered device is permitted for the intended use in the hazardous area. The nameplate can be found on the side of the transmitter housing.
- ▶ Observe the specifications in the separate supplementary documentation that is an integral part of these Instructions.

#### **Electromagnetic compatibility**

The measuring system complies with the general safety requirements in accordance with EN 61010, the EMC requirements of IEC/EN 61326 and NAMUR Recommendation NE 21 and NE 89.

#### **NOTICE**

- ▶ The unit must only be powered by a power supply that operates using an IEC 61010-1 compliant energy limited circuit, "SELV or Class 2 circuit".

## 3 Identification

### 3.1 Nameplate

#### The right device?

Compare and check the data on the nameplate of the device against the requirements of the measuring point:

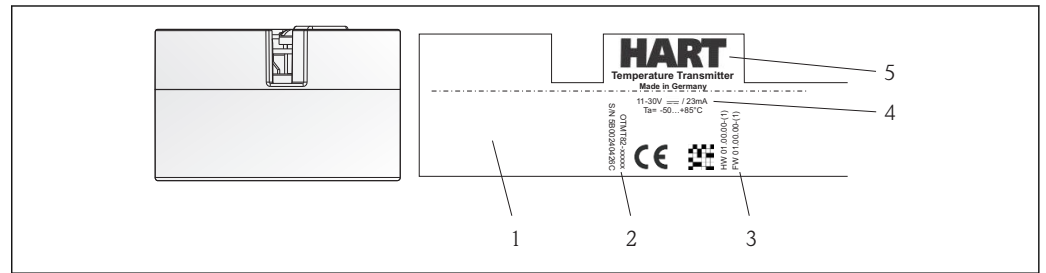



A0016153

 1 Nameplate of the head transmitter (example, Ex version)

- 1 Approvals with symbols, if available (as option)
- 2 Serial number
- 3 Device revision
- 4 Power supply and current consumption
- 5 Device designation and communication symbol

### 3.2 Scope of delivery

The scope of delivery of the device comprises:

- Temperature Head Transmitter
- Securing material
- Operating Instructions
- Additional documentation for devices which are suitable for use in the hazardous area ( ).

### 3.3 Certificates and approvals

The device left the factory in a safe operating condition. The device complies with the standards EN 61 010-1 "Protection Measures for Electrical Equipment for Measurement, Control, Regulation and Laboratory Procedures" and with the EMC requirements of IEC/EN 61326.

#### 3.3.1 CE mark, declaration of conformity

The device therefore meets the legal requirements of the EC guidelines. The manufacturer confirms a positive completion of all tests by fitting the unit with a CE mark.

#### 3.3.2 HART® protocol certification

The temperature transmitter is registered by HART® Communication. The device meets the requirements of the HART Communication Protocol Specifications, April 2001, Revision 6.0.

## 4 Installation instructions

### 4.1 Incoming acceptance, transport, storage

#### 4.1.1 Incoming acceptance

- Is the packaging or content damaged?
- Is the delivery complete and is anything missing? Check the scope of delivery against your order.

#### 4.1.2 Transport and storage

- Pack the device in such a way as to protect it reliably against impact for storage (and transportation). The original packaging provides optimum protection.
- The permitted storage temperature is -40 to +100 °C (-40 to 212 °F).

### 4.2 Installation conditions

#### 4.2.1 Dimensions

The dimensions of the device are provided in the 'Technical data' section (→ [33](#)).

#### 4.2.2 Installation point

- In the terminal head, flat face, as per DIN 43729, direct mounting on insert with cable entry (middle hole 7 mm)
- In the field housing, separated from the process

 It is also possible to mount the device on a top-hat rail as per EN 60715 using the DIN rail clip accessory .

Information about the conditions (such as the ambient temperature, degree of protection, climate class etc.) that must be present at the measuring point so that the device can be mounted correctly is provided in the 'Technical data' section (→ [33](#)).

When using in the hazardous area, the limit values of the certificates and approvals must be observed (see Ex-Safety Instructions).

### 4.3 Installation instructions

A Phillips head screwdriver is required to mount the head transmitter.

#### **NOTICE**

**Do not overtighten the mounting screws as this could damage the head transmitter.**

- ▶ Maximum torque = 1 Nm ( $\frac{3}{4}$  pound-feet).



### 4.3.1 Mounting

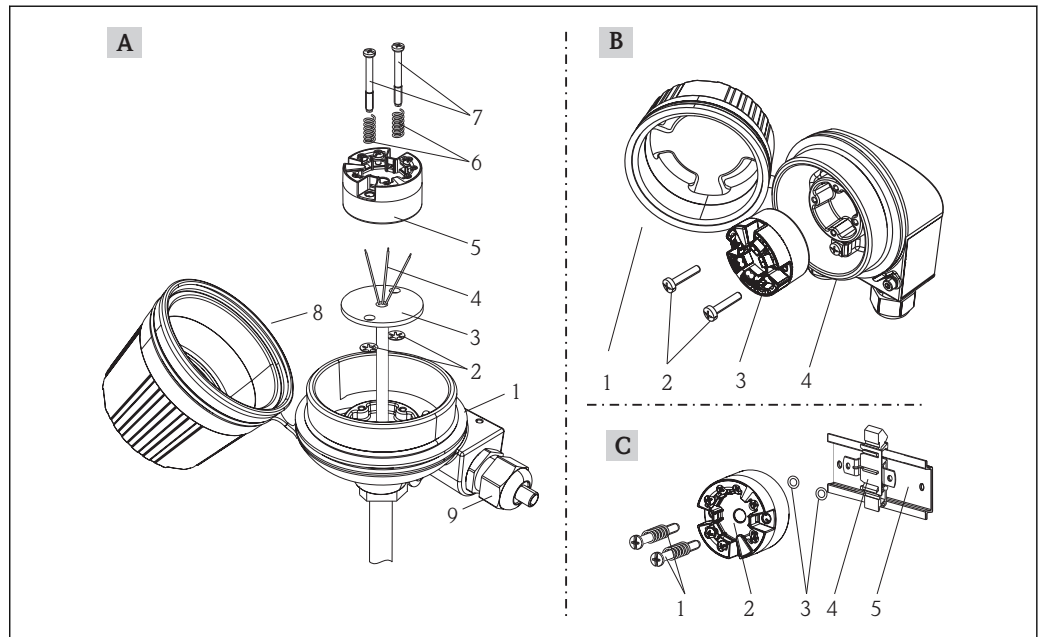

2 Head transmitter mounting (three versions)

A0019563

Item A	Mounting in a terminal head (terminal head flat face as per DIN 43729)
1	Terminal head
2	Circlips
3	Insert
4	Connection wires
5	Head transmitter
6	Mounting springs
7	Mounting screws
8	Terminal head cover
9	Cable entry

Procedure mounting in a terminal head, item A:

1. Open the terminal head cover (8).
2. Guide the connection wires (4) of the insert (3) through the center hole in the head transmitter (5).
3. Fit the mounting springs (6) on the mounting screws (7).
4. Guide the mounting screws (7) through the side boreholes of the head transmitter and the insert (3). Then fix both mounting screws with the snap rings (2).
5. Then tighten the head transmitter (5) along with the insert (3) in the terminal head.
6. After wiring, (→ 13) close the terminal head cover (8) back on tight.

Item B	Mounting in a field housing
1	Field housing cover
2	Mounting screws with springs
3	Head transmitter

Item B	Mounting in a field housing
4	Circlips
5	Field housing

Procedure mounting in a field housing, item B:

1. Open the cover (1) of the field housing (5).
2. Fit the mounting springs on the mounting screws (2) and guide the screws through the side boreholes of the head transmitter (3). Then fix both mounting screws with the snap rings (4).
3. Screw the head transmitter to the field housing.
4. After wiring, (→ 13) screw the field housing cover (1) back on.

Item C	Mounting on top-hat rail (top-hat rail as per IEC 60715)
1	Mounting screws with springs
2	Head transmitter
3	Circlips
4	DIN rail clip
5	DIN rail

Procedure mounting on top-hat rail, item C:

1. Press the DIN rail clip (4) onto the top-hat rail (5) until it engages with a click.
2. Fit the mounting springs on the mounting screws (1) and guide the screws through the side boreholes of the head transmitter (2). Then fix both mounting screws with the snap rings (3).
3. Screw the head transmitter (2) onto the DIN rail clip (4).

### 4.3.2 Mounting typical of North America

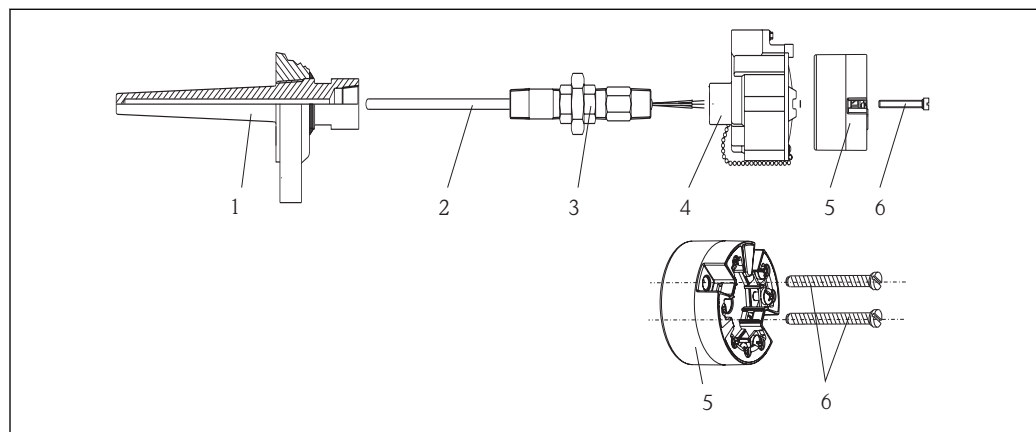

A0008520

3 Head transmitter mounting

- 1 Thermowell
- 2 Insert
- 3 Adapter, coupling
- 4 Terminal head
- 5 Head transmitter
- 6 Mounting screws

Thermometer design with thermocouples or RTD sensors and head transmitter:

1. Fit the thermowell (1) on the process pipe or the container wall. Secure the thermowell according to the instructions before the process pressure is applied.
2. Fit the necessary neck tube nipples and adapter (3) on the thermowell.
3. Make sure sealing rings are installed if such rings are needed for harsh environmental conditions or special regulations.
4. Guide the mounting screws (6) through the lateral bores of the head transmitter (7).
5. Position the head transmitter (5) in the terminal head (4) in such a way that the bus cable (terminals 1 and 2) point to the cable entry.
6. Using a screwdriver, screw down the head transmitter (5) in the terminal head (4).
7. Guide the connection wires of the insert (3) through the lower cable entry of the terminal head (4) and through the middle hole in the head transmitter (5). Wire the connection wires and transmitter with one another.
8. Screw the terminal head (4), with the integrated and wired head transmitter, onto the ready-mounted nipple and adapter (3).

#### NOTICE

**The terminal head cover must be secured properly to meet the requirements for explosion protection.**

- After wiring, securely screw the terminal head cover back on.

### 4.3.3 Mounting the display

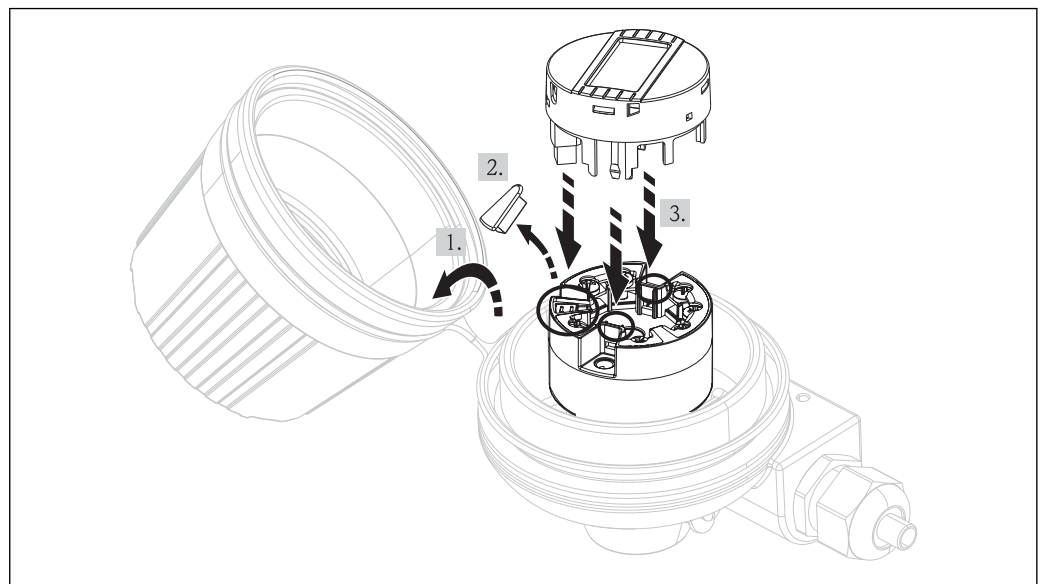

4 Mounting the display

1. Loosen the screw on the terminal head cover. Flip back the terminal head cover (1).
2. Remove the cover of the display connection area (2). Fit the display module onto the mounted and wired head transmitter. The fastening pins (3) must click securely into place on the head transmitter.
3. After mounting, securely tighten the terminal head cover.

**i** The display can only be used with terminal head covers with a viewing window (e.g. Endress+Hauser TA30).

## 4.4 Post-installation check

After installing the device, always run the following final checks:

Device condition and specifications	Notes
Is the device undamaged (visual inspection)?	-
Do the ambient conditions match the device specification (e.g. ambient temperature, measuring range, etc.)?	See 'Technical data' section (→  33)

## 5 Wiring

### ⚠ CAUTION

- ▶ Switch off power supply before installing or connecting the device. Failure to observe this may result in destruction of parts of the electronics.
- ▶ When installing Ex-approved devices in a hazardous area, please take special note of the instructions and connection schematics in the respective Ex documentation added to these Operating Instructions. The local supplier representative is available for assistance if required.
- ▶ Do not occupy the display connection. An incorrect connection can destroy the electronics.

For wiring a mounted head transmitter, proceed as follows:

1. Open the cable gland and the housing cover on the terminal head or the field housing.
2. Feed the cables through the opening in the cable gland.
3. Connect the cables as shown in (→ 13). If the head transmitter is fitted with spring terminals, pay particular attention to the information in the "Connecting to spring terminals" section (→ 14).
4. Retighten the cable gland and close the housing cover.

In order to avoid connection errors always take note of the hints given in the section connection check!

### 5.1 Quick wiring guide

#### Terminal assignment

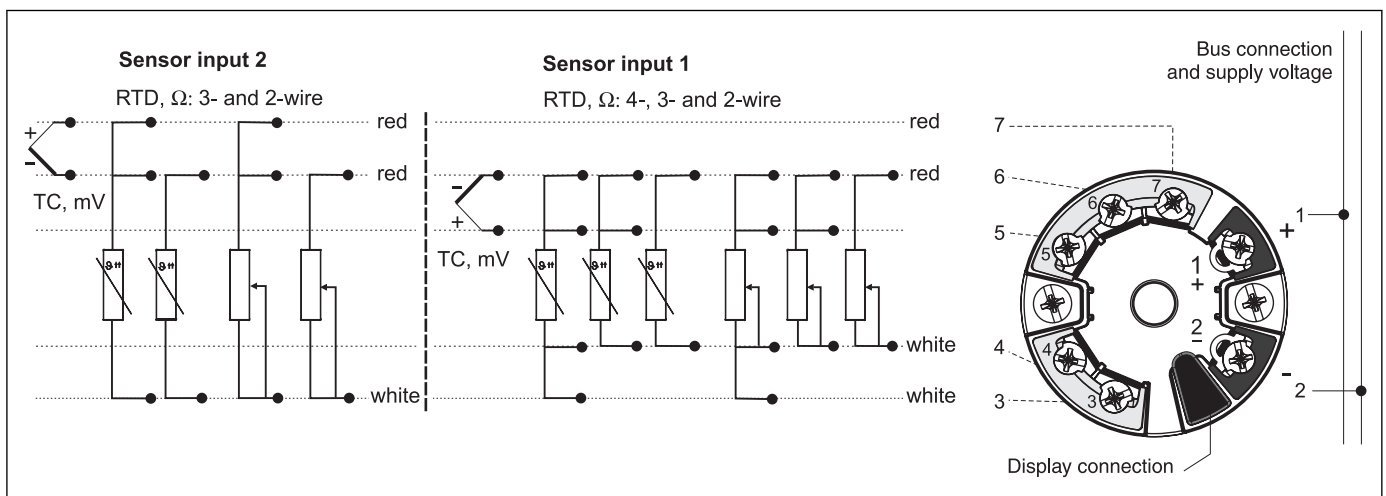



5 Wiring the head transmitter

### NOTICE

- ▶ ⚠ ESD - electrostatic discharge. Protect the terminals from electrostatic discharge. Failure to observe this may result in destruction or malfunction of parts of the electronics.

## 5.2 Connecting the sensor cables

Terminal assignment of the sensor terminals (→  5,  13).

### NOTICE

**When connecting 2 sensors, ensure that there is no galvanic connection between the sensors (e.g. caused by sensor elements that are not isolated from the thermowell). The resulting equalizing currents distort the measurement considerably.**

- ▶ The sensors must remain galvanically isolated from one another by connecting each sensor separately to a transmitter. The transmitter provides sufficient galvanic isolation (> 2 kV AC) between the input and output.

*The following connection combinations are possible when both sensor inputs are assigned:*

		Sensor input 1			
		RTD or resistance transmitter, two-wire	RTD or resistance transmitter, three-wire	RTD or resistance transmitter, four-wire	Thermocouple (TC), voltage transmitter
Sensor input 2	RTD or resistance transmitter, two-wire	✓	✓	-	✓
	RTD or resistance transmitter, three-wire	✓	✓	-	✓
	RTD or resistance transmitter, four-wire	-	-	-	-
	Thermocouple (TC), voltage transmitter	✓	✓	✓	✓

## 5.3 Connecting the power supply and signal cables

### CAUTION

- ▶ Switch off power supply before installing or connecting the head transmitter. Failure to observe this may result in destruction of parts of the electronics.

### Cable specification

- A normal device cable suffices if only the analog signal is used.
- A shielded cable is recommended for HART® communication. Take the plant grounding concept into consideration.

Please also observe the general procedure on (→  13).

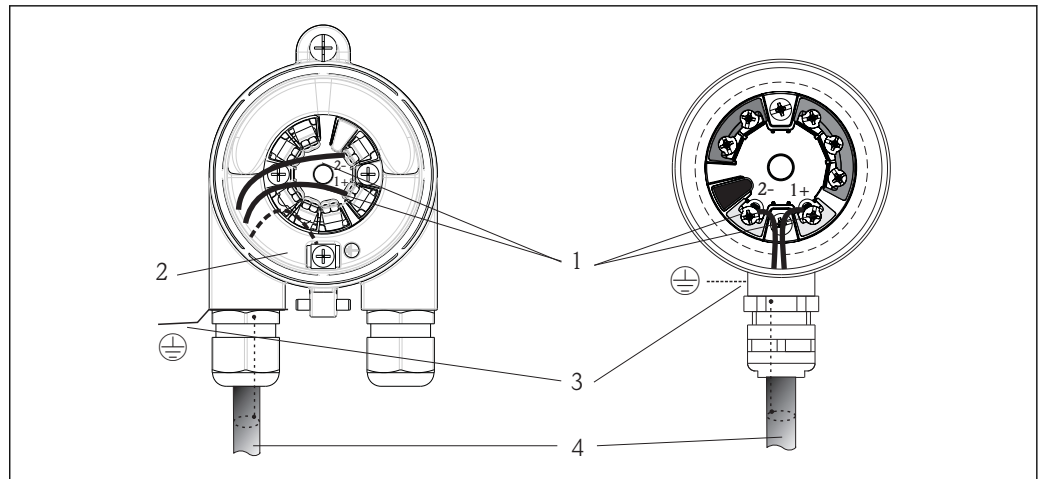

6 Connecting the signal cable and power supply - left: installed in field housing, right: installed in terminal head

- A Terminals for HART®-protocol and power supply
- B Internal ground terminal
- C External ground terminal
- D Shielded signal cable (recommended for HART® protocol)

- i The terminals for connecting the signal cable (1+ and 2-) are protected against reverse polarity.
  - Conductor cross-section:
    - Max. 2.5 mm<sup>2</sup> for screw terminals
    - Max. 1.5 mm<sup>2</sup> for spring terminals

## 5.4 Shielding and grounding

Optimum electromagnetic compatibility (EMC) can only be guaranteed if the system components and, in particular, the lines are shielded and the shield forms as complete a cover as possible. A shield coverage of 90% is ideal.

- To ensure an optimum EMC protective effect when communicating with HART®, connect the shield as often as possible to the reference ground.
- For reasons of explosion protection, you should refrain from grounding however.

To comply with both requirements, three different types of shielding are possible when communicating with HART®:

- Shielding at both ends
- Shielding at one end on the feed side with capacitance termination at the field device
- Shielding at one end on the feed side

Experience shows that the best results with regard to EMC are achieved in most cases in installations with one-sided shielding on the feed side (without capacitance termination at the field device). Appropriate measures with regard to input wiring must be taken to allow unrestricted operation when EMC interference is present. These measures have been taken into account for this device. Operation in the event of disturbance variables as per NAMUR NE21 is thus guaranteed. Where applicable, national installation regulations and guidelines must be observed during the installation! Where there are large differences in potential between the individual grounding points, only one point of the shielding is connected directly with the reference ground. In systems without potential equalization, therefore, cable shielding of fieldbus systems should only be grounded on one side, for example at the supply unit or at safety barriers.

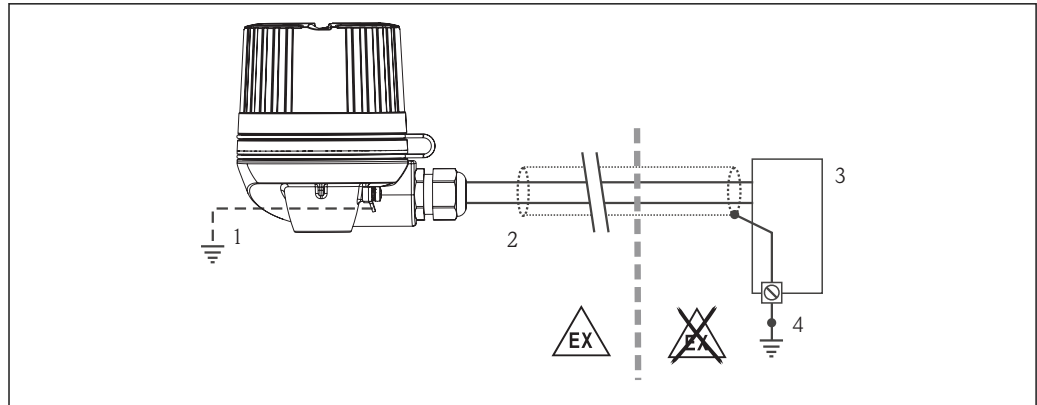

A0019556

7 Shielding and grounding the signal cable at one end with HART® communication

- 1 Optional grounding of the field device, isolated from cable shielding
- 2 Grounding of the cable shield at one end
- 3 Supply unit
- 4 Grounding point for HART® communication cable shield

### NOTICE

If the shielding of the cable is grounded at more than one point in systems without potential matching, power supply frequency equalizing currents can occur that damage the signal cable or have a serious effect on signal transmission.

- In such cases the shielding of the signal cable is to be grounded on only one side, i.e. it must not be connected to the ground terminal of the housing (terminal head, field housing). The shield that is not connected should be insulated!

## 5.5 Post-connection check

Device condition and specifications	Notes
Is the device or cable undamaged (visual inspection)?	—
Electrical connection	Notes
Does the supply voltage match the specifications on the nameplate?	U = 11 to 42 V DC
Do the cables have adequate strain relief?	—
Are the power supply and signal cables correctly connected?	(→ 13)
Are all the screw terminals well tightened and have the connections of the spring terminals been checked?	—
Are all the cable entries installed, tightened and sealed?	—
Are all the housing covers installed and tightened?	—



## 6 Operating options

### 6.1 Overview of operation options

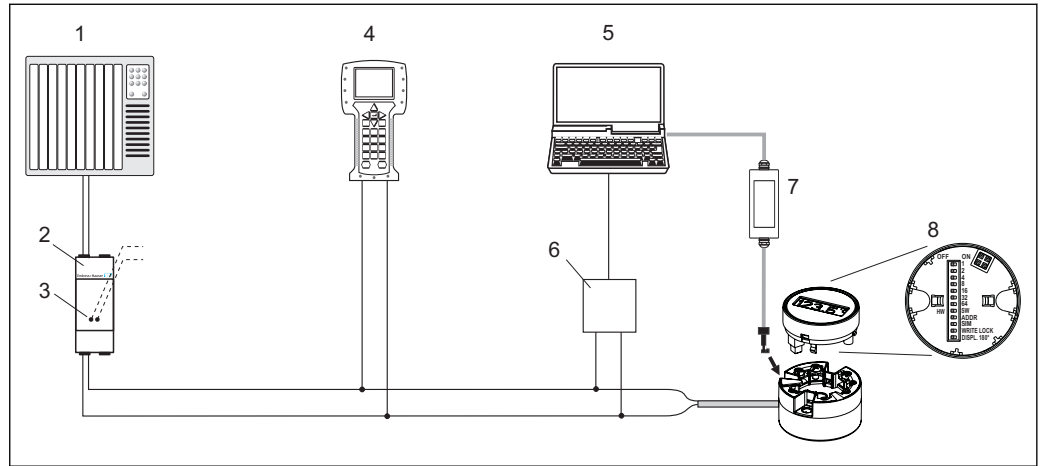

A0014460

#### 8 Operating options of the head transmitter

- 1 PLC (programmable logic controller)
- 2 Transmitter power supply unit (with communication resistor)
- 3 Connection for HART® modems
- 4 Field Communicator 375, 475
- 5 Computer with operating tool (e.g. FieldCare, AMS Device Manager, SIMATIC PDM)
- 6 HART® modem, e. g. FXA19x, RS232- or USB-connection (E+H)
- 7 Interface adapter FXA291 (E+H) for connecting to the CDI (Common Data Interface) interface
- 8 Local operation via DIP switches on the rear of the optional display



Display and operating elements are only available locally if the head transmitter was ordered with a display unit!

## 6.2 Structure and function of the operating menu

### 6.2.1 Structure of the operating menu

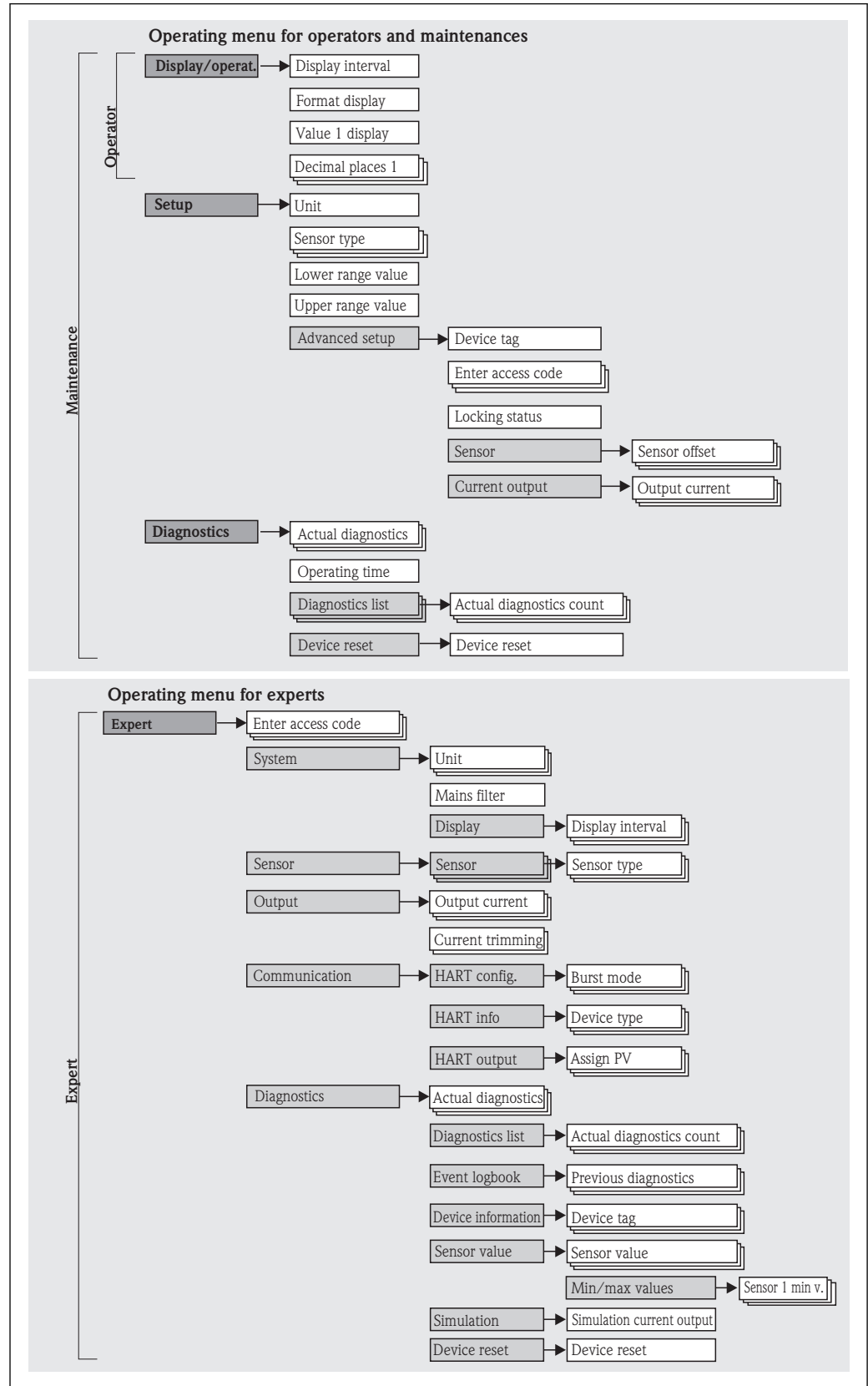

## 6.2.2 Submenus and user roles

Certain parts of the menu are assigned to certain user roles. Each user role corresponds to typical tasks within the lifecycle of the device.

User role	Typical tasks	Menu	Content/meaning
Operator	Tasks during operation: <ul style="list-style-type: none"> <li>■ Configuration of the display.</li> <li>■ Reading measured values.</li> </ul>	"Display/operation"	Contains all the parameters that are required in ongoing operation: configuration of the measured value display (displayed values, display format, etc.).
Maintenance	Commissioning: <ul style="list-style-type: none"> <li>■ Configuration of the measurement.</li> <li>■ Configuration of data processing (scaling, linearization, etc.).</li> <li>■ Configuration of the analog measured value output.</li> </ul>	"Setup"	Contains all parameters for commissioning: <ul style="list-style-type: none"> <li>■ <b>Setup parameters</b> Once values have been set for these parameters, the measurement should generally be completely configured.</li> <li>■ <b>"Advanced setup" submenu</b> Contains additional submenus and parameters: <ul style="list-style-type: none"> <li>– For more accurate configuration of the measurement (adaptation to special measuring conditions).</li> <li>– For converting the measured value (scaling, linearization).</li> <li>– For scaling the output signal.</li> </ul> </li> </ul>
	Fault elimination: <ul style="list-style-type: none"> <li>■ Diagnosing and eliminating process errors.</li> <li>■ Interpretation of device error messages and correcting associated errors.</li> </ul>	"Diagnostics"	Contains all parameters for detecting and analyzing errors: <ul style="list-style-type: none"> <li>■ <b>Diagnostic list</b> Contains up to 3 currently pending error messages.</li> <li>■ <b>Event logbook</b> Contains the 5 most recent error messages (no longer pending).</li> <li>■ <b>"Device information" submenu</b> Contains information for identifying the device.</li> <li>■ <b>"Measured values" submenu</b> Contains all current measured values.</li> <li>■ <b>"Simulation" submenu</b> Is used to simulate measured values or output values.</li> <li>■ <b>"Device reset" submenu</b></li> </ul>
Expert	Tasks that require detailed knowledge of the function of the device: <ul style="list-style-type: none"> <li>■ Commissioning measurements under difficult conditions.</li> <li>■ Optimal adaptation of the measurement to difficult conditions.</li> <li>■ Detailed configuration of the communication interface.</li> <li>■ Error diagnostics in difficult cases.</li> </ul>	"Expert"	Contains all parameters of the device (including those that are already in one of the other menus). This menu is structured according to the function blocks of the device: <ul style="list-style-type: none"> <li>■ <b>"System" submenu</b> Contains all higher-order device parameters that do not pertain either to measurement or the measured value communication.</li> <li>■ <b>"Sensors" submenu</b> Contains all parameters for configuring the measurement.</li> <li>■ <b>"Output" submenu</b> Contains all parameters for configuring the analog current output.</li> <li>■ <b>"Communication" submenu</b> Contains all parameters for configuring the digital communication interface.</li> <li>■ <b>"Diagnostics" submenu</b> Contains all parameters for detecting and analyzing errors.</li> </ul>

## 6.3 Measured value display and operating elements

### 6.3.1 Display

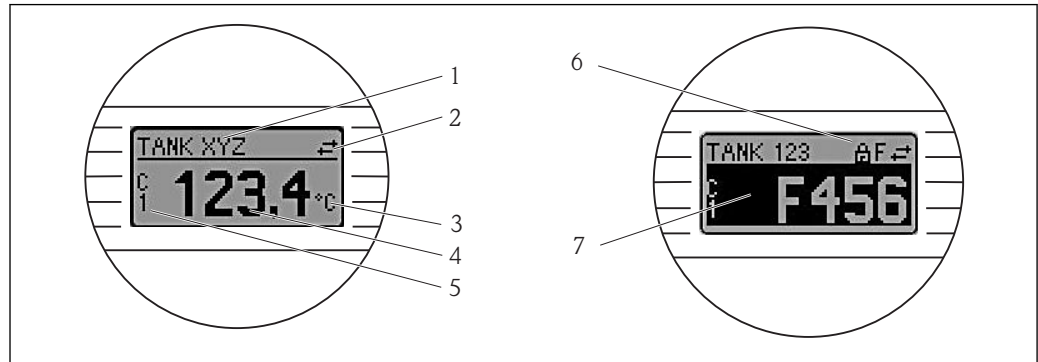

A0008549

9 Optional LC display of the head transmitter

Item No.	Function	Description
1	Displays the TAG	TAG, 32 characters long.
2	'Communication' symbol	The communication symbol appears when read and write-accessing via the fieldbus protocol.
3	Unit display	Unit display for the measured value displayed.
4	Measured value display	Displays the current measured value.
5	Value/channel display S1, S2, DT, PV, I, %	e.g. S1 for a measured value from channel 1 or DT for the device temperature
6	'Configuration locked' symbol	The 'configuration locked' symbol appears when configuration is locked via the hardware.
7	Status signals	
	Symbols	Meaning
	<b>S</b>	<b>"Out of specification"</b> The device is being operated outside its technical specifications (e.g. during startup or a cleaning).
	<b>C</b>	<b>"Service mode"</b> The device is in service mode (e.g. during a simulation).
	<b>M</b>	<b>"Maintenance required"</b> Maintenance is required. The measured value is still valid. The display alternates between the measured value and the status message.
<b>F</b>	<b>"Operating error" error message</b> An operating error has occurred. The measured value is no longer valid. The display alternates between the error message and "----" (no valid measured value present), see 'Diagnostic events' section.	

### 6.3.2 Local operation

You can make hardware settings for the fieldbus interface using miniature switches (DIP switches) on the rear of the optional display.

 The user has the option of ordering the display with the transmitter, or as an accessory for subsequent mounting.

**NOTICE**

- ▶  ESD - electrostatic discharge. Protect the terminals from electrostatic discharge. Failure to observe this may result in destruction or malfunction of parts of the electronics.

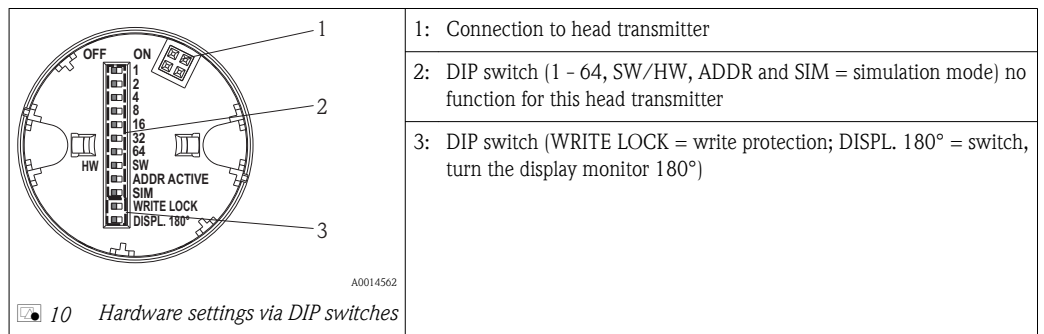

Procedure for setting the DIP switch:

1. Open the cover of the terminal head or field housing.
2. Remove the attached display from the head transmitter.
3. Configure the DIP switch on the rear of the display accordingly. In general: switch to ON = function enabled, switch to OFF = function disabled.
4. Fit the display onto the head transmitter in the correct position. The head transmitter accepts the settings within one second.
5. Secure the cover back onto the terminal head or field housing.

**Switching write protection on/off**

Write protection is switched on and off via a DIP switch on the rear of the optional attachable display. When write protection is active, parameters cannot be modified. This is shown on the display as a key symbol when a hardware lock is activated ("WRITE LOCK" to "ON"). Write protection prevents any write access to the parameters.

**Turning the display**

The display can be rotated 180° using the "DISPL. 180°" DIP switch. The setting is retained when the display is removed.

**6.4 Access to the operating menu via the operating tool****6.4.1 FieldCare****Function scope**

FDT/DTM-based plant asset management tool from Endress+Hauser. Access takes place via the HART® protocol or CDI (Common Data Interface) interface.

**NOTICE**

**Before accessing the device via the CDI (Common Data Interface) interface to the interface adapter FXA291, disconnect the transmitter from the power supply, terminals (1+) and (2-).**

- ▶ Failure to comply with this instruction can result in damage to parts of the electronics.

**Source for device description files**

See data (→  23).

## 6.4.2 AMS Device Manager

### Function scope

Program from Emerson Process Management for operating and configuring measuring devices via the HART® protocol.

### Source for device description files

See data (→  23).

## 6.4.3 SIMATIC PDM

### Function scope

Program from Siemens for the operation, configuration, maintenance and diagnosis of intelligent field devices via the HART® protocol.

### Source for device description files

See data (→  23).

## 6.4.4 Field Communicator 375/475

### Function scope

Industrial handheld terminal from Emerson Process Management for remote configuration and measured value display via the HART® protocol.

### Source for device description files

See data (→  23).

## 7 Integrating the transmitter via the HART® protocol

### Version data for the device

Firmware Version	01.00.zz	<ul style="list-style-type: none"> <li>■ On the title page of the Operating instructions</li> <li>■ On the nameplate</li> <li>■ Parameter <b>firmware version</b> Diagnostics → Device info → Firmware version</li> </ul>
Manufacturer ID	00b5	<b>Manufacturer ID</b> parameter Diagnostics → Device info → Manufacturer ID
Device type ID	0081	<b>Device type</b> parameter Diagnostics → Device info → Device type
HART protocol revision	6.0	—
Device revision	1	<ul style="list-style-type: none"> <li>■ On the transmitter nameplate</li> <li>■ <b>Device revision</b> parameter Diagnostics → Device info → Device revision</li> </ul>

The following is a list of the suitable device description (DD) file for each individual operating tool with information on the source.

### Operating tools

Operating tool	Sources for obtaining device descriptions (DD)
FieldCare (Endress+Hauser)	<a href="http://www.endress.com">www.endress.com</a> → Download Area
AMS Device Manager (Emerson Process Management)	Internet-download on the manufacturer's website
Field Communicator 375, 475 (Emerson Process Management)	Use update function of handheld terminal

### 7.1 HART device variables and measured values

The following measured values are assigned to the device variables at the factory:

#### Device variables for temperature measurement

Device variable	Measured value
Primary device variable (PV)	Sensor 1
Secondary device variable (SV)	Device temperature
Tertiary device variable (TV)	Sensor 1
Quaternary device variable (QV)	Sensor 1

 It is possible to change the assignment of device variables to process variables in the **Expert** → **Communication** → **HART output** menu.

### 7.2 Device variables and measured values

The following measured values are assigned to the individual device variables:

Device variable code	Measured value
0	Sensor 1
1	Sensor 2

Device variable code	Measured value
2	Device temperature
3	Average of sensor 1 and sensor 2
4	Difference between sensor 1 and sensor 2
5	Sensor 1 (backup sensor 2)
6	Sensor 1 with switchover to sensor 2 if a limit value is exceeded
7	Average of sensor 1 and sensor 2 with backup

 The device variables can be queried by a HART® master via HART® command 9 or 33.



## 8 Commissioning



### 8.1 Function check

Before commissioning the measuring point make sure that all final checks have been carried out:

- Checklist "Post-installation check", (→  12)
- Checklist "Post-connection check", (→  13)

### 8.2 Switching on the transmitter

Once the final checks have been successfully completed, it is time to switch on the supply voltage. The transmitter performs a number of internal test functions after power-up. As this procedure progresses, the following sequence of messages appears on the display:

Step	Display
1	"Display" text and firmware version of the display
2	Firm logo
3	Device name with firmware and hardware versions
4	Information on the sensor configuration (sensor element and type of connection)
5	Set measuring range
6a	Current measured value or
6b	Current status message  If the switch-on procedure is not successful, the relevant diagnostics event, depending on the cause, is displayed. A detailed list of diagnostic events and the corresponding troubleshooting instructions can be found in the "Diagnostics and troubleshooting" section (→  27).

The device is operational after approx. 8 seconds, and the plug-in display after approx. 12 seconds in normal operating mode! Normal measuring mode commences as soon as the switch-on procedure is completed. Measured values and status values appear on the display.

### 8.3 Enabling configuration

If the device is locked and the parameter settings cannot be changed, it must first be enabled via the hardware lock. The device is locked using the hardware if the keyhole symbol appears in the header of the measured value display. To unlock the device, switch the write protection switch on the back of the display to the "OFF" position (→  21).

## 9 Maintenance

In general, no specific maintenance is required for this device.

## 10 Accessories

Various accessories, which can be ordered separately from your supplier, are available for the device. Detailed information on the order code in question can be obtained from your service organization. When ordering accessories, please specify the serial number of the device!

The following accessories are contained in the scope of delivery:



- Operating Instructions
- Supplementary documentation for use in hazardous areas
- Mounting material for head transmitter

Accessory
Display, pluggable
Field housing for head transmitter, aluminum, IP 66, dimensions B x H x T: 100 x 100 x 60 mm (3.94" x 3.94" x 2.36")
DIN rail clip according to IEC 60715 for head transmitter mounting
Standard - DIN mounting set (2 screws + springs, 4 securing disks and 1 display connector cover)
US - M4 mounting screws (2 screws M4 and 1 display connector cover)

# 11 Diagnostics and troubleshooting

## 11.1 Troubleshooting

Always start troubleshooting with the checklists below if faults occur after start up or during operation. This takes you directly (via various queries) to the cause of the problem and the appropriate remedial measures.

 Due to its design, the device cannot be repaired. However, it is possible to send the device in for examination. See the information in the "Return" section (→  32).

### General errors

Problem	Possible cause	Remedy
Device not reacting.	Supply voltage does not match that specified on the nameplate.	Apply the correct voltage.
	No contact between connecting cables and terminals.	Check the contacting of the cables and correct if necessary.
Output current < 3.6 mA	Signal cable is wired incorrectly.	Check wiring.
	Electronics are defective.	Replace the device.
HART communication not working.	Missing or incorrectly installed communication resistor.	Install the communication resistor (250 Ω) correctly.
	HART-Modem is connected incorrectly.	Connect HART-Modem correctly.
	HART-Modem is not set to "HART".	Set HART-Modem selector switch to "HART".

### Checking the display

Problem	Possible cause	Remedy
No display visible	No supply voltage	<ul style="list-style-type: none"> <li>■ Check the supply voltage at the head transmitter terminals + and -.</li> <li>■ Ensure that the display module holders are correctly seated and that the display module is properly connected to the head transmitter, (→  8).</li> <li>■ If possible test the display module with another suitable head transmitter.</li> </ul>
	The display module is defective.	Replace the module.
	The electronics of the head transmitter are defective.	Replace the head transmitter.

### Application errors without status messages for RTD sensor connection

Problem	Possible cause	Remedy
Measured value is incorrect/ inaccurate	Incorrect sensor orientation.	Install the sensor correctly.
	Heat conducted by sensor.	Observe the face-to-face length of the sensor.
	Device programming is incorrect (number of wires).	Change the <b>Connection type</b> device function.
	Device programming is incorrect (scaling).	Change scaling.
	Incorrect RTD configured.	Change the <b>Sensor type</b> device function.
	Sensor connection.	Check that the sensor is connected correctly.

Problem	Possible cause	Remedy
	The cable resistance of the sensor (2-wire) was not compensated.	Compensate the cable resistance.
	Offset incorrectly set.	Check offset.
Failure current ( $\leq 3.6$ mA or $\geq 21$ mA)	Faulty sensor.	Check the sensor.
	RTD connected incorrectly.	Connect the connecting cables correctly (terminal diagram).
	Incorrect device programming (e.g. number of wires).	Change the <b>Connection type</b> device function.
	Incorrect programming.	Incorrect sensor type set in the <b>Sensor type</b> device function. Set the correct sensor type.

*Application errors without status messages for TC sensor connection*

Problem	Possible cause	Remedy
Measured value is incorrect/ inaccurate	Incorrect sensor orientation.	Install the sensor correctly.
	Heat conducted by sensor.	Observe face-to-face length of the sensor.
	Device programming is incorrect (scaling).	Change scaling.
	Incorrect thermocouple type (TC) configured.	Change the <b>Sensor type</b> device function.
	Incorrect comparison measuring point set.	Set the correct reference junction ( $\rightarrow$ 52).
	Interference via the thermocouple wire welded in the thermowell (interference voltage coupling).	Use a sensor where the thermocouple wire is not welded.
	Offset incorrectly set.	Check offset.
Failure current ( $\leq 3.6$ mA or $\geq 21$ mA)	Faulty sensor.	Check the sensor.
	Sensor is connected incorrectly.	Connect the connecting cables correctly (terminal diagram).
	Incorrect programming.	Incorrect sensor type set in the <b>Sensor type</b> device function. Set the correct sensor type.

## 11.2 Diagnostics events

### 11.2.1 Displaying diagnostic events

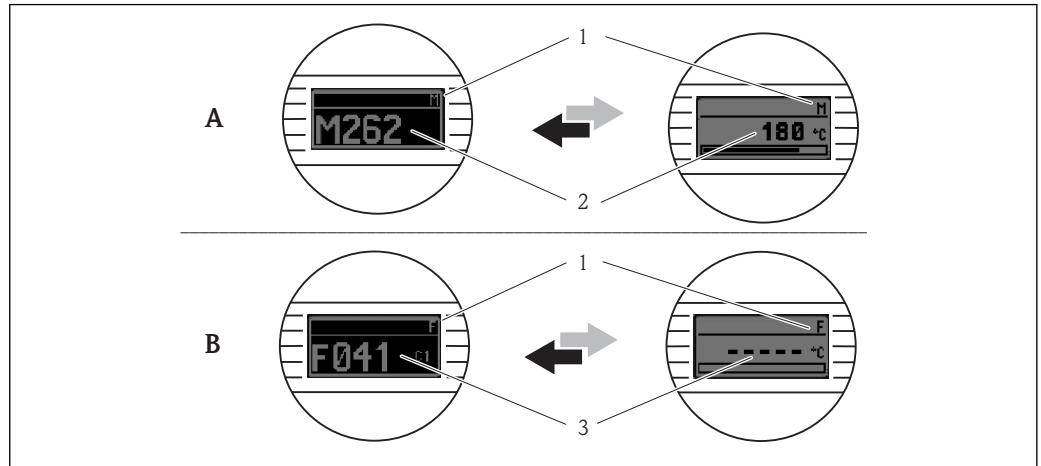

A0014837

A Display in the event of a warning

B Display in the event of an alarm

1 Status signal in the header

2 The display alternates between the primary measured value and the status - indicated by the appropriate letter (M, C or S) - plus the defined error number.

3 The display alternates between "---" (no valid measured value) and the status - indicated by the appropriate letter (F) - plus the defined error number.

#### Status signals

Symbol	Event category	Meaning
<b>F</b>	Operating error	An operating error has occurred. The measured value is no longer valid.
<b>M</b>	Maintenance required	Maintenance is required. The measured value is still valid.
<b>C</b>	Service mode	The device is in service mode (e.g. during a simulation).
<b>S</b>	Out of specification	The device is being operated outside its technical specifications (e.g. during startup or a cleaning)

#### Diagnostic behavior

<b>Alarm</b>	The measurement is interrupted. The signal outputs take on the defined alarm condition. A diagnostic message is generated (status signal F).
<b>Warning</b>	The device continues to measure. A diagnostic message is generated (status signals M, C or S).

### Diagnostics event and event text

The fault can be identified using the diagnostics event. The event text helps you do so by providing information about the fault.

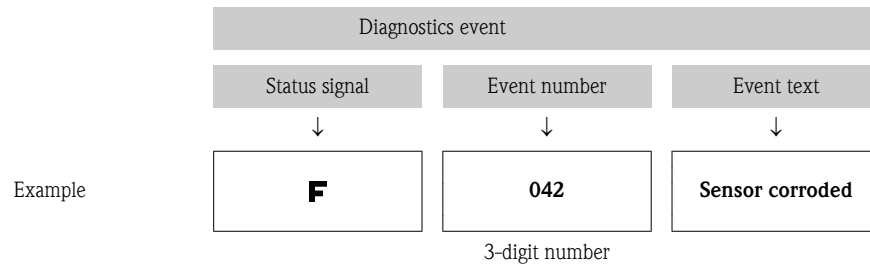

If two or more diagnostic messages are pending simultaneously, only the message with the highest priority is shown. Additional pending diagnostic messages are shown in the **Diagnostics list** submenu (→ 63).

**i** Past diagnostic messages that are no longer pending are shown in the **Event logbook** submenu (→ 64).

### 11.2.2 Overview of diagnostics events

Each diagnostics event is assigned a certain event level at the factory. The user can change this assignment for certain diagnostics events.

**i** Valid for diagnostics numbers 006, 041, 042, 043, 101 and 102.

The relevant sensor input for these diagnostics events can be identified by the parameter **Actual diag channel** or on the optional attachable display.

Diagnostics number	Event text	Remedial measures	Status signal from the factory	Event level from the factory
			Changeable in	
<b>Diagnostics for the sensor</b>				
001	Device error	Replace electronics.	F	Alarm
006	Sensor redundancy active	1. Check electrical connection. 2. Replace sensor. 3. Check connection type.	M	Warning
041	Sensor broken	1. Check electrical connection. 2. Replace sensor. 3. Check connection type.	F	Alarm
042	Sensor corroded	1. Check electrical connection sensor. 2. Replace sensor.	M	Warning <sup>1)</sup>
			F	
043	Short circuit	1. Check electrical connection. 2. Replace sensor.	F	Alarm
044	Sensor drift	1. Check sensors. 2. Check process temperature.	M	Warning <sup>1)</sup>
			F, S	
045	Operating range	1. Check ambient temperature. 2. Check external reference measurement.	F	Alarm
101	Sensor value too low	1. Check process temperature. 2. Check sensor. 3. Check sensor type.	F	Alarm

Diagnosis number	Event text	Remedial measures	Status signal from the factory	Event level from the factory
			Changeable in	
102	Sensor value too high	1. Check process temperature. 2. Check sensor. 3. Check sensor type.	F	Alarm
104	Backup active	1. Check electrical connection sensor 1. 2. Replace sensor 1. 3. Check connection type.	M	Warning
105	Calibration interval	1. Execute calibration and reset calibration interval. 2. Switch off calibration counter.	M	Warning <sup>1)</sup>
			F	
106	Backup not available	1. Check electrical connection sensor 2. 2. Replace sensor 2. 3. Check connection type.	M	Warning
<b>Diagnostics for the electronics</b>				
201	Electronic error	Replace electronics.	F	Alarm
221	Electronic reference	Replace electronics.	F	Alarm
241	Electronic software	1. Device restart. 2. Device reset. 3. Replace electronics.	F	Alarm
261	Electronic modules	Replace electronics.	F	Alarm
262	Module connection	1. Check whether the retainers and the connection of the display module are correctly seated on the head transmitter. 2. Test the display module with other suitable head transmitters. 3. Display module defective? Replace module.	M	Warning
283	Memory content	Replace electronics.	F	Alarm
301	Supply voltage	1. Increase supply voltage. 2. Check electrical connection for corrosion.	F	Alarm
<b>Diagnostics for the configuration</b>				
401	Factory reset	Please wait during the reset process.	C	Warning
402	Configuration initialization	Please wait during the initialization process	C	Warning
411	Up-/Download	Please wait during the Up-/Download process.	C	Warning
431	Factory calibration	Replace electronics.	F	Alarm
435	Linearization	1. Check configuration of sensor parameters. 2. Check configuration of special sensor linearization. 3. Contact service organisation. 4. Replace electronics.	F	Alarm
437	Configuration	1. Check configuration of sensor parameters. 2. Check configuration of special sensor linearization. 3. Check transmitter settings. 4. Contact service organisation.	F	Alarm
451	Data handling	Please wait during the data handling process.	C	Warning
483	Simulation input	Deactivate simulation.	C	Warning
485	Simulation measured value			
491	Simulation current output			

Diagnosis number	Event text	Remedial measures	Status signal from the factory	Event level from the factory
			Changeable in	
<b>Diagnostics for the process</b>				
803	Current loop	1. Check wiring. 2. Replace electronics.	F	Alarm
842	Process limit	Check the adjusted range of the analog output.	M F, S	Warning <sup>1)</sup>
925	Device temperature	Ensure ambient temperature as per specification.	S F	Warning

1) Event level can be changed in: 'Alarm' or 'Warning'

### 11.3 Spare parts

*Always quote the serial number of the device when ordering spare parts!*

Type
Adapter for top-hat rail mounting, DIN rail clip as per IEC 60715
Standard - DIN securing set (2 screws and springs, 4 shaft lock-down rings, 1 plug for display interface)
US - M4 securing set (2 screws and 1 plug for the display interface)

### 11.4 Return

For later reuse or to return the device to the service organization of your supplier, the device must be packed in such a way as to protect it from impact and damage. The original packaging material offers the best protection here. When sending the unit in to be checked, please enclose a note with a description of the error and the application.

### 11.5 Disposal

The device contains electronic components and must, therefore, be disposed of as electronic waste in the event of disposal. Please pay particular attention to the local regulations governing waste disposal in your country.

### 11.6 Software history and overview of compatibility

#### Revision history

The firmware version (FW) on the nameplate and in the Operating Instructions indicates the device release: XX.YY.ZZ (example 01.02.01).

XX	Change to main version. No longer compatible. The device and Operating Instructions change.
YY	Change to functions and operation. Compatible. The Operating Instructions change.
ZZ	Fixes and internal changes. No changes to the Operating Instructions.

Date	Firmware Version	Modifications
01/11	1.00.zz	Original firmware



## 12 Technical data

### 12.1 Input

Measured variable                      Temperature (temperature-linear transmission behavior), resistance and voltage.

Type of input                              Two independent sensors can be connected. The measuring inputs are not galvanically isolated from each other.

Type of input	Designation	Measuring range limits	
<b>Resistance thermometer (RTD)</b> as per IEC 60751:2008 ( $\alpha = 0.003851$ )  as per JIS C1604:1984 ( $\alpha = 0.003916$ )  as per DIN 43760 IPTS-68 ( $\alpha = 0.006180$ )  as per GOST 6651-94 ( $\alpha = 0.003910$ ) (for Cu: $\alpha = 0.004280$ )  as per OIML R84: 2003 and GOST 6651-94 ( $\alpha = 0.006170$ ) (for Cu: $\alpha = 0.004260$ )  as per OIML R84: 2003 ( $\alpha = 0.004280$ )	Pt100 Pt200 Pt500 Pt1000	-200 to +850 °C (-328 to +1 562 °F) -200 to +850 °C (-328 to +1 562 °F) -200 to +500 °C (-328 to +932 °F) -200 to +250 °C (-328 to +482 °F)	
	Pt100	-200 to +510 °C (-328 to +950 °F)	
	Ni100 Ni120	-60 to +250 °C (-76 to +482 °F) -60 to +250 °C (-76 to +482 °F)	
	Pt100 Pt50 Cu50	-200 to +850 °C (-328 to +1 562 °F) -185 to +1 100 °C (-301 to +2 012 °F) -175 to +200 °C (-283 to +392 °F)	
	Cu50 Ni100 Ni120	-50 to +200 °C (-58 to +392 °F) -60 to +180 °C (-76 to +356 °F) -60 to +180 °C (-76 to +356 °F)	
	Cu50	-180 to +200 °C (-292 to +392 °F)	
	Pt100 (Callendar van Dusen) Nickel polynomial Copper polynomial	The measuring range limits are specified by entering the limit values that depend on the coefficients A to C and R0.	
	<ul style="list-style-type: none"> <li>■ Type of connection: 2-wire, 3-wire or 4-wire connection, sensor current: <math>\leq 0.3</math> mA</li> <li>■ With 2-wire circuit, compensation of wire resistance possible (0 to 30 <math>\Omega</math>)</li> <li>■ With 3-wire and 4-wire connection, sensor wire resistance to max. 50 <math>\Omega</math> per wire</li> </ul>		
<b>Resistance transmitter</b>	Resistance $\Omega$	10 to 400 $\Omega$ 10 to 2000 $\Omega$	
<b>Thermocouples (TC)</b> to IEC 584 part 1    to ASTM E988  to DIN 43710	Type B (PtRh30-PtRh6) Type E (NiCr-CuNi) Type J (Fe-CuNi) Type K (NiCr-Ni) Type N (NiCrSi-NiSi) Type R (PtRh13-Pt) Type S (PtRh10-Pt) Type T (Cu-CuNi)	+40 to +1 820 °C (+104 to +3 308 °F) -270 to +1 000 °C (-454 to +1 832 °F) -210 to +1 200 °C (-346 to +2 192 °F) -270 to +1 372 °C (-454 to +2 501 °F) -270 to +1 300 °C (-454 to +2 372 °F) -50 to +1 768 °C (-58 to +3 214 °F) -50 to +1 768 °C (-58 to +3 214 °F) -260 to +400 °C (-436 to +752 °F)	Recommended temperature range: +100 to +1 500 °C (+212 to +2 732 °F) 0 to +750 °C (+32 to +1 382 °F) +20 to +700 °C (+68 to +1 292 °F) 0 to +100 °C (+32 to +2 012 °F) 0 to +100 °C (+32 to +2 012 °F) 0 to +1 400 °C (+32 to +2 552 °F) 0 to +1 400 °C (+32 to +2 552 °F) -185 to +350 °C (-301 to +662 °F)
	Type C (W5Re-W26Re) Type D (W3Re-W25Re)	0 to +2 315 °C (+32 to +4 199 °F) 0 to +2 315 °C (+32 to +4 199 °F)	0 to +2 000 °C (+32 to +3 632 °F) 0 to +2 000 °C (+32 to +3 632 °F)
	Type L (Fe-CuNi) Type U (Cu-CuNi)	-200 to +900 °C (-328 to +1 652 °F) -200 to +600 °C (-328 to +1 112 °F)	0 to +700 °C (+32 to +1 292 °F) -185 to +400 °C (-301 to +752 °F)
	<ul style="list-style-type: none"> <li>■ Internal cold junction (Pt100)</li> <li>■ External cold junction: configurable value -40 to +85 °C (-40 to +185 °F)</li> <li>■ Max. sensor resistance 10 k<math>\Omega</math> (if sensor resistance is greater than 10 k<math>\Omega</math>, error message as per NAMUR NE89)</li> </ul>		
	<b>Voltage transmitter (mV)</b>	Millivolt transmitter (mV)	-20 to 100 mV

The following connection combinations are possible when both sensor inputs are assigned:

		Sensor input 1			
		RTD or resistance transmitter, 2-wire	RTD or resistance transmitter, 3-wire	RTD or resistance transmitter, 4-wire	Thermocouple (TC), voltage transmitter
Sensor input 2	RTD or resistance transmitter, 2-wire	✓	✓	-	✓
	RTD or resistance transmitter, 3-wire	✓	✓	-	✓
	RTD or resistance transmitter, 4-wire	-	-	-	-
	Thermocouple (TC), voltage transmitter	✓	✓	✓	✓

## 12.2 Output

Output signal	Analog output	4 to 20 mA, 20 to 4 mA (can be inverted)
	Signal encoding	FSK ±0.5 mA via current signal
	Data transmission rate	1200 baud
	Galvanic isolation	U = 2 kV AC (input/output)

Failure information	<b>Failure information as per NAMUR NE43:</b>
	Failure information is created if the measuring information is missing or not valid. A complete list of all the errors occurring in the measuring system is created.
Underranging	Linear drop from 4.0 to 3.8 mA
Overranging	Linear increase from 20.0 to 20.5 mA
Failure, e.g. sensor breakage; sensor short circuit	≤ 3.6 mA ("low") or ≥ 21 mA ("high"), can be selected The "high" alarm setting can be set between 21.6 mA and 23 mA, thus providing the flexibility needed to meet the requirements of various control systems.

Load	$R_{b \max} = (U_{b \max} - 11 \text{ V}) / 0.023 \text{ A (current output)}$
	<p>Supply voltage (V DC)</p> <p style="text-align: right;">A0014066-EN</p>

Linearization/transmission behavior	Temperature-linear, resistance-linear, voltage-linear
-------------------------------------	---

Mains voltage filter	50/60 Hz
----------------------	----------

Filter 1st order digital filter: 0 to 120 s

Current consumption

- 3.6 to 23 mA
- Minimum current consumption  $\leq 3.5$  mA
- Current limit  $\leq 23$  mA

Protocol-specific data		
HART® version		6
Device address in multi-drop mode		Software setting addresses 0 to 63
Write protection		Hardware setting for activating write protection
Device description files (DD)		Information and files are available from your supplier or online at: <a href="http://www.hartcomm.org">www.hartcomm.org</a>
Load (communication resistor)		min. 250 $\Omega$

Switch-on delay 5 s, during switch-on delay  $I_a \leq 3.8$  mA

## 12.3 Power supply

Supply voltage  $U = 11$  to 42 V DC (non-hazardous area), reverse polarity protected. Values for hazardous area see chapter 'Certificates and approvals' ( $\rightarrow$  39).

Residual ripple Perm. residual ripple  $U_{ss} \leq 3$  V at  $U_b \geq 13.5$  V,  $f_{max.} = 1$  kHz

## 12.4 Performance characteristics

Response time Measured value update  $< 1$  s per channel, depending on the type of sensor and connection method

Reference operating conditions

- Calibration temperature:  $+25$  °C  $\pm 5$  K ( $77$  °F  $\pm 9$  °F)
- Supply voltage: 24 V DC
- 4-wire circuit for resistance adjustment

Maximum measured error The accuracy data are typical values and correspond to a standard deviation of  $\pm 3 \sigma$  (normal distribution), i.e. 99.8 % of all the measured values achieve the given values or better values.

	Designation/measuring range	Performance characteristics	
		Digital	D/A <sup>1)</sup>
<b>Resistance thermometer (RTD)</b>	Pt100, Ni100, Ni120	0.1 °C (0.18 °F)	0.03 %
	Pt500	0.3 °C (0.54 °F)	0.03 %
	Cu50, Pt50, Pt1000	0.2 °C (0.36 °F)	0.03 %
	Pt200	1.0 °C (1.8 °F)	0.03 %
<b>Thermocouples (TC)</b>	Type: K, J, T, E, L, U	0.25 °C (0.45 °F)	0.03 %
	Type: N, C, D	0.5 °C (0.9 °F)	0.03 %
	Type: S, B, R	1.0 °C (1.8 °F)	0.03 %

	Designation/measuring range	Performance characteristics	
<b>Resistance transmitters (Ω)</b>	10 to 400 Ω	±0.04 Ω	0.03 %
	10 to 2000 Ω	±0.8 Ω	0.03 %
<b>Voltage transmitter (mV)</b>	-20 to 100 mV	±10 μV	0.03 %

1) % refers to the set span. Accuracy = digital + D/A accuracy

Physical input measuring range of sensors	
10 to 400 Ω	Cu50, Cu100, polynomial RTD, Pt50, Pt100, Ni100, Ni120
10 to 2000 Ω	Pt200, Pt500, Pt1000
-20 to 100 mV	Thermocouples type: B, C, D, E, J, K, L, N, R, S, T, U

Sensor adjustment

**Sensor transmitter matching**

RTD sensors are one of the most linear temperature measuring elements. Nevertheless, the output must be linearized. To significantly improve temperature measurement accuracy, the device allows the use of two methods:

- Callendar-Van-Dusen coefficients (Pt100 resistance thermometer)

The Callendar-Van-Dusen equation is described as:

$$R_T = R_0[1 + AT + BT^2 + C(T - 100)T^3]$$

The coefficients A, B and C are used to match the sensor (platinum) and transmitter in order to improve the accuracy of the measuring system. The coefficients for a standard sensor are specified in IEC 751. If no standard sensor is available or if greater accuracy is required, the coefficients for each sensor can be determined specifically with the aid of sensor calibration.

- Linearization for copper/nickel resistance thermometers (RTD)

The polynomial equation for copper/nickel is as follows:

$$R_T = R_0(1 + AT + BT^2)$$

The coefficients A and B are used for the linearization of nickel or copper resistance thermometers (RTD). The exact values of the coefficients derive from the calibration data and are specific to each sensor.

Sensor transmitter matching using one of the methods explained above significantly improves the temperature measurement accuracy of the entire system. This is because the transmitter uses the specific data pertaining to the connected sensor to calculate the measured temperature, instead of using the standardized sensor curve data.

**1-point adjustment (offset)**

Shifts the sensor value

**2-point adjustment (sensor trimming)**

Correction (slope and offset) of the measured sensor value at transmitter input

**Current trimming (current output fine adjustment)**

Correction of the 4 or 20 mA current output value

Non-repeatability

Input	
10 to 400 Ω	15 mΩ
10 to 2000 Ω	100 ppm * measured value
-20 to 100 mV	4 μV

<b>Output</b>
$\leq 2 \mu\text{A}$

Influence of the supply voltage  $\leq \pm 0.0025\%/V$ , with reference to the span

Long-term stability  $\leq 0.1 \text{ }^\circ\text{C}/\text{year}$  ( $\leq 0.18 \text{ }^\circ\text{F}/\text{year}$ ) or  $\leq 0.05 \text{ } \%/ \text{year}$   
Data under reference operating conditions. % refers to the set span. The larger value is valid.

Influence of ambient temperature (temperature drift) Total temperature drift = input temperature drift + output temperature drift

<b>Impact on accuracy when ambient temperature changes by 1 K (1.8 °F):</b>	
Input 10 to 400 $\Omega$	Typ. 0.001 % of the measured value, min. 1 m $\Omega$
Input 10 to 2000 $\Omega$	Typ. 0.001 % of the measured value, min. 10 m $\Omega$
Input -20 to 100 mV	Typ. 0.001 % of the measured value, min. 0.2 $\mu\text{V}$
Output 4 to 20 mA	Typ. 0.0015 % of the span

<b>Typical sensitivity of resistance thermometers</b>		
Pt: $0.00385 * R_{\text{nom}}/K$	Cu: $0.0043 * R_{\text{nom}}/K$	Ni: $0.00617 * R_{\text{nom}}/K$
Example Pt100: $0.00385 * 100 \Omega/K = 0.385 \Omega/K$		

<b>Typical sensitivity of thermocouples:</b>					
B: 9 $\mu\text{V}/K$ at 1000 $^\circ\text{C}$ (1832 $^\circ\text{F}$ )	C: 18 $\mu\text{V}/K$ at 1000 $^\circ\text{C}$ (1832 $^\circ\text{F}$ )	D: 20 $\mu\text{V}/K$ at 1000 $^\circ\text{C}$ (1832 $^\circ\text{F}$ )	E: 81 $\mu\text{V}/K$ at 500 $^\circ\text{C}$ (932 $^\circ\text{F}$ )	J: 56 $\mu\text{V}/K$ at 500 $^\circ\text{C}$ (932 $^\circ\text{F}$ )	K: 43 $\mu\text{V}/K$ at 500 $^\circ\text{C}$ (932 $^\circ\text{F}$ )
L: 60 $\mu\text{V}/K$ at 500 $^\circ\text{C}$ (932 $^\circ\text{F}$ )	N: 38 $\mu\text{V}/K$ at 500 $^\circ\text{C}$ (932 $^\circ\text{F}$ )	R: 13 $\mu\text{V}/K$ at 1000 $^\circ\text{C}$ (1832 $^\circ\text{F}$ )	S: 11 $\mu\text{V}/K$ at 1000 $^\circ\text{C}$ (1832 $^\circ\text{F}$ )	T: 46 $\mu\text{V}/K$ at 100 $^\circ\text{C}$ (212 $^\circ\text{F}$ )	U: 70 $\mu\text{V}/K$ at 500 $^\circ\text{C}$ (932 $^\circ\text{F}$ )

#### Example of calculating the measured error with ambient temperature drift:

Input temperature drift  $\Delta\theta = 10 \text{ K}$  (18  $^\circ\text{F}$ ), Pt100, measuring range 0 to 100  $^\circ\text{C}$  (32 to 212  $^\circ\text{F}$ ).  
Maximum process temperature: 100  $^\circ\text{C}$  (212  $^\circ\text{F}$ )

Measured resistance value: 138.5  $\Omega$  (IEC 60751) at maximum process temperature

Typical temperature drift in  $\Omega$ : (0.001 % of 138.5  $\Omega$ ) \* 10 = 0.01385  $\Omega$

Conversion to Kelvin: 0.01385  $\Omega$  / 0.385  $\Omega/K$  = 0.04 K (0.072  $^\circ\text{F}$ )

Influence of the reference junction (internal cold junction) Pt100 DIN IEC 60751 Cl. B (internal cold junction with thermocouples TC)

## 12.5 Environment

Ambient temperature range -40 to +85  $^\circ\text{C}$  (-40 to +185  $^\circ\text{F}$ ), for hazardous area see Ex documentation and 'Certificates and approvals' section ( $\rightarrow$  39)

Storage temperature -40 to +100  $^\circ\text{C}$  (-40 to +212  $^\circ\text{F}$ )

Altitude Up to 4000 m (4374.5 yards) above mean sea level as per IEC 61010-1, CAN/CSA C22.2 No. 61010-1

Climate class As per IEC 60654-1, Class C

Humidity ■ Condensation permitted as per IEC 60 068-2-33  
 ■ Max. rel. humidity: 95% as per IEC 60068-2-30

Degree of protection IP 20. In the installed state, depends on the terminal head or field housing used.

Vibration 25 to 100 Hz for 4g (increased vibration stress) as per GL-guidelines, chapter 2, edition 2003

Electromagnetic compatibility (EMC) **CE compliance**  
 Electromagnetic compatibility in accordance with all the relevant requirements of the EN 61326 series and NAMUR Recommendation EMC (NE21). Details are provided in the Declaration of Conformity. All tests were passed both with and without ongoing digital HART® communication.

ESD (electrostatic discharge)	EN/IEC 61000-4-2	6 kV cont., 8 kV air	
Electromagnetic fields	EN/IEC 61000-4-3	0.08 to 2.7 GHz	10 V/m
Burst (fast transients)	EN/IEC 61000-4-4	2 kV	
Surge (surge voltage)	EN/IEC 61000-4-5	0.5 kV sym. 1 kV assym.	
Conducted RF	EN/IEC 61000-4-6	0.01 to 80 MHz	10 V

Measuring category Measuring category II as per IEC 61010-1. The measuring category is provided for measuring on power circuits that are directly connected electrically with the low-voltage network.

Degree of contamination Pollution degree 2 as per IEC 61010-1.

## 12.6 Mechanical construction

Design, dimensions

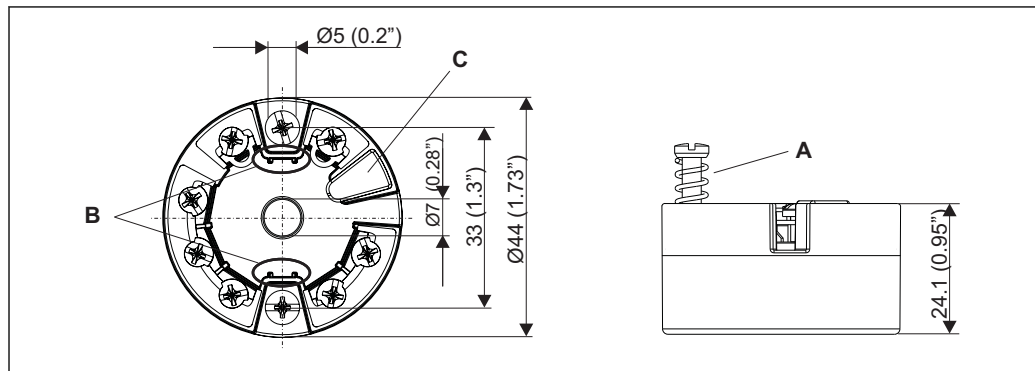

11 Version with screw terminals, dimensions in mm (in).

- A Spring travel  $L \geq 5$  mm (not for US - M4 securing screws)
- B Fasteners for attachable measured value display
- C Interface for contacting the measured value display

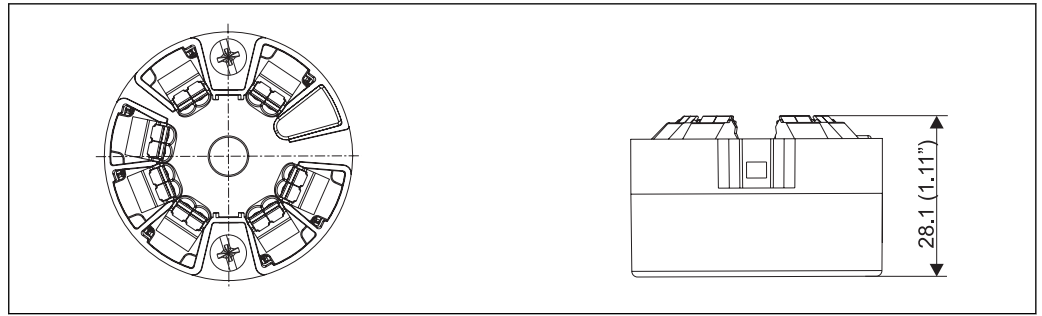

12 Version with spring terminals. The dimensions are identical to the version with screw terminals, apart from the housing height, dimensions in mm (in).

A0007672

Weight Approx. 40 to 50 g (1.4 to 1.8 oz)

Materials All the materials used comply with RoHS specifications:

- Housing: polycarbonate (PC), complies with UL94, V-2 UL recognized
- Terminals:
  - Screw terminals: nickel-plated brass and gold-plated contact
  - Spring terminals: tin-plated brass, contact spring V2A
- Potting: WEVO PU 403 FP / FL

Terminals Choice of screw or spring terminals for sensor and fieldbus wires:

Terminal version	Wire version	Conductor cross-section
<b>Screw terminals</b> (with latches at the fieldbus terminals for easy connection of a handheld terminal, e.g. DXR375)	Rigid or flexible	$\leq 2.5 \text{ mm}^2$ (14 AWG)
<b>Spring terminals</b> (wire version, stripped length = min. 10 mm (0.39"))	Rigid or flexible	0.2 to 1.5 mm <sup>2</sup> (24 to 16 AWG)
	Flexible with wire-end ferrules without plastic ferrule	0.25 to 1.5 mm <sup>2</sup> (24 to 16 AWG)
	Flexible with wire-end ferrules with plastic ferrule	0.25 to 0.75 mm <sup>2</sup> (24 to 18 AWG)

**i** It is advisable not to use wire end ferrules when connecting flexible wires to spring terminals.

## 12.7 Certificates and approvals

CE mark The measuring system meets the legal requirements of the EC guidelines. The manufacturer confirms successful testing of the device by affixing to it the CE mark.

ATEX **i** More detailed information about currently available Ex versions (ATEX, FM, CSA etc.) can be supplied by your sales organization on request. Separate Ex documentation, which is available upon request, contains all the data relevant for explosion protection.

FM approval	<p>Labeling:  IS / I / 1 / ABCD / T4 Ta = 85°C — Entity*;  NI / I / 2 / ABCD / T4 Ta = 85°C — NIFW*;  I / 0 / AEx ia IIC T4 Ta = 85°C — Entity*;  *= Entity and NIFW parameters in accordance with <b>Control Drawings (CD)</b></p> <p>Application:  ■ Intrinsic safety  ■ Non-incendive</p> <p>For connection data see table in separate Ex documentation</p>
CSA approval (Canadian Standard Association)	<p>Labeling:  Class I, Div. 1, Groups A, B, C, D Entity*;  Ex ia IIC  Class I, Div. 2, Groups A, B, C, D, NIFW*;  Ex nA II  *= Entity and NIFW parameters in accordance with <b>Control Drawings (CD)</b></p> <p>Application:  ■ Intrinsic safety  ■ Non-incendive</p> <p>For connection data see table in separate Ex documentation</p>
Other standards and guidelines	<ul style="list-style-type: none"> <li>■ IEC 60529: Degrees of protection provided by enclosures (IP code)</li> <li>■ IEC 61010-1:2001, 2nd Edition: Safety requirements for electrical equipment for measurement, control and laboratory use</li> <li>■ EN 61326 Series: Electromagnetic compatibility (EMC requirements)</li> <li>■ Guidelines for the performance of type approvals, chapter 2, edition 2003: Vibrations</li> <li>■ NAMUR: International user association of automation technology in process industries (<a href="http://www.namur.de">www.namur.de</a>)</li> </ul>
Equipment safety UL	Equipment safety as per UL61010-1, 2nd Edition
CSA GP	CAN/CSA-C22.2 No. 61010-1, 2nd Edition
HART® communication	The temperature transmitter is registered by HART® Communication. The device meets the requirements of the HART Communication Protocol Specifications, April 2001, Revision 6.0.

















## 13 Operating menu and parameter description





 The following table lists all parameters the menus "Display/operation, Setup, Diagnostics and Expert" may contain. The page number refers to where a description of the parameter can be found.

Depending on the device version and parametrization some parameters will not be available in a given situation. For details on the conditions refer to the "Prerequisite" category in the description of the respective parameter. All the configuration options of the menus "Display/operation, Setup, Diagnostics" are available in the "Expert" setup mode as well as additional parameters that are reserved for experienced users.

This symbol  marks the navigation path to the parameter via an operating tool (e.g. FieldCare).

<b>Display/operation</b> →	Display interval	(→  47)
	Format display	(→  47)
	Value 1 display	(→  48)
	Decimal places 1	(→  48)
	Value 2 display	(→  49)
	Decimal places 2	(→  49)
	Value 3 display	(→  50)
	Decimal places 3	(→  50)

<b>Setup</b> →	Unit	(→  51)
	Sensor type 1	(→  51)
	Connection type 1	(→  51)
	2-wire compensation 1	(→  52)
	Reference junction 1	(→  52)
	RJ preset value 1	(→  52)
	Sensor type 2	(→  51)
	Connection type 2	(→  51)
	2-wire compensation 2	(→  52)
	Reference junction 2	(→  52)
	RJ preset value 2	(→  52)
	Assign current output (PV)	(→  53)
	Lower range value	(→  53)
	Upper range value	(→  54)

<b>Setup</b> →	<b>Advanced setup</b> →	Device tag	(→  56)
		Enter access code	(→  55)
		Access status tooling	(→  55)
		Device temperature Alarm	(→  56)
		Locking status	(→  56)

<b>Setup →</b>	<b>Advanced setup →</b>	<b>Sensor →</b>	Sensor offset 1	(→ 57)
			Sensor offset 2	(→ 57)
			Corrosion detection	(→ 57)
			Drift/difference mode	(→ 57)
			Drift/difference alarm category	(→ 58)
			Drift/difference set point	(→ 58)
			Sensor switch set point	(→ 58)

<b>Setup →</b>	<b>Advanced setup →</b>	<b>Current output →</b>	Output current	(→ 59)
			Measuring mode	
			Out of range category	(→ 60)
			Failure mode	(→ 60)
			Failure current	(→ 61)
			Current trimming 4 mA	(→ 61)
			Current trimming 20 mA	(→ 61)

































<b>Diagnostics →</b>	Actual diagnostics 1	(→ 62)
	Remedy information	(→ 62)
	Previous diagnostics 1	(→ 62)
	Operating time	(→ 62)

<b>Diagnostics →</b>	<b>Diagnostics list →</b>	Actual diagnostics count	(→ 63)
		Actual diagnostics	(→ 62)
		Actual Diag Channel	(→ 63)

<b>Diagnostics →</b>	<b>Event logbook →</b>	Previous diagnostics n	(→ 64)
		Previous diag n channel	(→ 64)

<b>Diagnostics →</b>	<b>Device information →</b>	Device tag	(→ 56)
		Serial number	(→ 65)
		Firmware version	(→ 65)
		Device name	(→ 65)
		Order code	(→ 65)
		Configuration counter	(→ 66)

<b>Diagnostics →</b>	<b>Measured values →</b>	Sensor 1 value	(→ 66)
		Sensor 2 value	(→ 66)
		Device temperature	(→ 66)

<b>Diagnostics →</b>	<b>Measured values →</b>	<b>Min/max values →</b>	Sensor n min value	(→  67)
			Sensor n max value	(→  67)
			Reset sensor min/max values	(→  67)
			Device temperature max.	(→  67)
			Device temperature min.	(→  68)
			Reset device temp. min/max values	(→  68)
<b>Diagnostics →</b>	<b>Simulation →</b>	Simulation current output	(→  68)	
		Value current output	(→  69)	
<b>Diagnostics →</b>	<b>Device reset →</b>	Device reset	(→  69)	
<b>Expert →</b>	Enter access code		(→  55)	
	Access status tooling		(→  55)	
	Locking status		(→  56)	
<b>Expert →</b>	<b>System →</b>	Unit	(→  51)	
		Damping	(→  70)	
		Alarm delay	(→  70)	
		Mains filter	(→  70)	
		Device temperature alarm	(→  56)	
<b>Expert →</b>	<b>System →</b>	<b>Display →</b>	Display interval	(→  47)
			Format display	(→  47)
			Value 1 display	(→  48)
			Decimal places 1	(→  48)
			Value 2 display	(→  49)
			Decimal places 2	(→  49)
			Value 3 display	(→  50)
			Decimal places 3	(→  50)
<b>Expert →</b>	<b>Sensor →</b>	<b>Sensor n <sup>1)</sup>→</b>	Sensor type n	(→  51)
			Connection type n	(→  51)
			2-wire compensation n	(→  52)
			Reference junction n	(→  52)
			RJ preset value	(→  52)
			Sensor offset n	(→  57)
			Sensor n lower limit	(→  71)

	Sensor n upper limit	(→ 71)
	Serial no. sensor	(→ 71)

1) n = number of the sensor inputs (1 or 2)

<b>Expert →</b>	<b>Sensor →</b>	<b>Sensor n →</b>	<b>Sensor Trimming →</b>	Sensor trimming	(→ 72)
				Sensor trimming lower value	(→ 72)
				Sensor trimming upper value	(→ 73)
				Sensor trimming min span	(→ 73)





<b>Expert →</b>	<b>Sensor →</b>	<b>Sensor n <sup>1)</sup>→</b>	<b>Linearization →</b>	Sensor n lower limit	(→ 71)
				Sensor n upper limit	(→ 71)
				Call./v. Dusen coeff. R0, A, B, C	(→ 74)
				Polynom coeff. R0, A, B	(→ 75)









1) n = number of the sensor inputs (1 or 2)









<b>Expert →</b>	<b>Sensor →</b>	<b>Diagnostic settings →</b>	Corrosion detection	(→ 57)
			Drift/difference mode	(→ 57)
			Drift/difference alarm category	(→ 58)
			Drift/difference set point	(→ 58)
			Sensor switch set point	(→ 58)
			Calibration counter start	(→ 75)
			Calibration counter alarm category	(→ 76)
			Calibration counter start value	(→ 76)
			Calibration countdown	(→ 76)





<b>Expert →</b>	<b>Output →</b>	Output current	(→ 59)
		Measuring mode	(→ 77)
		Lower range value	(→ 53)
		Upper range value	(→ 54)
		Out of range category	(→ 60)
		Failure mode	(→ 60)
		Failure current	(→ 61)
		Current trimming 4 mA	(→ 61)
		Current trimming 20 mA	(→ 61)



<b>Expert →</b>	<b>Communication →</b>	<b>HART configuration →</b>	Device tag	(→ 77)
			HART short tag	(→ 77)
			HART address	(→ 77)
			No. of preambels	(→ 78)



	Burst mode	(→  78)
	Burst command	(→  78)
	Burst variable slots 0...3	(→  79)
	Configuration changed	(→  80)
	Reset Configuration Changed Flag	(→  80)





<b>Expert →</b>	<b>Communication →</b>	<b>HART info →</b>	Device type	(→  80)
			Device revision	(→  80)
			HART revision	(→  80)
			HART descriptor	(→  81)
			HART message	(→  81)
			Hardware revision	(→  85)
			RevSW	(→  81)
			HART date code	(→  81)

<b>Expert →</b>	<b>Communication →</b>	<b>HART output →</b>	Assign current output (PV)	(→  53)
			PV	(→  82)
			Assign SV	(→  82)
			SV	(→  82)
			Assign TV	(→  83)
			TV	(→  83)
			Assign QV	(→  83)
			QV	(→  83)

<b>Expert →</b>	<b>Diagnostics →</b>	Actual diagnostics 1	(→  62)
		Remedy information	(→  62)
		Previous diagnostics 1	(→  62)
		Operating time	(→  62)

<b>Expert →</b>	<b>Diagnostics →</b>	<b>Diagnostics list →</b>	Actual diagnostics count	(→  63)
			Actual diagnostics	(→  62)
			Actual Diag Channel	(→  63)

<b>Expert →</b>	<b>Diagnostics →</b>	<b>Event logbook →</b>	Previous diagnostics n	(→  64)
			Previous diag n channel	(→  64)

<b>Expert →</b>	<b>Diagnostics →</b>	<b>Device information →</b>	Device tag	(→  56)
			Serial number	(→  65)
			Firmware version	(→  65)
			Devic name	(→  65)

	Order code	(→ ⓘ 65)
	Extended order code	(→ ⓘ 84)
	Extended order code 2	(→ ⓘ 84)
	Extended order code 3	(→ ⓘ 84)
	ENP version	(→ ⓘ 84)
	Device revision	(→ ⓘ 80)
	Manufacturer ID	(→ ⓘ 84)
	Manufacturer	(→ ⓘ 85)
	Hardware revision	(→ ⓘ 85)
	Configuration counter	(→ ⓘ 66)

<b>Expert →</b>	<b>Diagnostics →</b>	<b>Measured values →</b>	Sensor n value	(→ ⓘ 66)
			Sensor n raw value	(→ ⓘ 85)
			Device temperature	(→ ⓘ 66)

<b>Expert →</b>	<b>Diagnostics →</b>	<b>Measured values →</b>	<b>Min/max values →</b>	Sensor n min value	(→ ⓘ 67)
				Sensor n max value	(→ ⓘ 67)
				Reset sensor min/max values	(→ ⓘ 67)
				Device temperature max.	(→ ⓘ 67)
				Device temperature min.	(→ ⓘ 68)
				Reset device temp. min/max values	(→ ⓘ 68)

<b>Expert →</b>	<b>Diagnostics →</b>	<b>Simulation →</b>	Simulation current output	(→ ⓘ 68)
			Value current output	(→ ⓘ 69)

<b>Expert →</b>	<b>Diagnostics →</b>	<b>Device reset →</b>	Device reset	(→ ⓘ 69)
-----------------	----------------------	-----------------------	--------------	----------

## 13.1 "Display/operation" menu

The settings for displaying the measured value on the optional plug-in display are made in the "Display/Operation" menu. The following parameters can be found in "Display/operation" and "Expert → System → Display".



These settings do not have any effect on the output values of the transmitter. They are only used to configure how information is shown on the display.

---

### Display interval

---

#### Navigation



Display/operation → Display interval  
Expert → System → Display → Display interval

#### Description

Use this function to set the length of time the measured values are displayed if the values alternate on the display. The display only alternates between values if more than one measured value is defined.



- The **Value 1 display - Value 3 display** parameters are used to specify what measured values are shown on the display (→ 48).
- The display format of the displayed measured values is specified using the **Format display** parameter.

#### User input

4 to 20 s

#### Factory settings

4 s

---

### Format display

---

#### Navigation



Display/operation → Format display  
Expert → System → Display → Format display

#### Description

Use this function to select how the measured value is shown on the local display. The display format **Measured value** or **Measured value with bar graph** can be configured.

#### Options:

- Value only
- Value + Bargraph

#### Factory settings

Value only

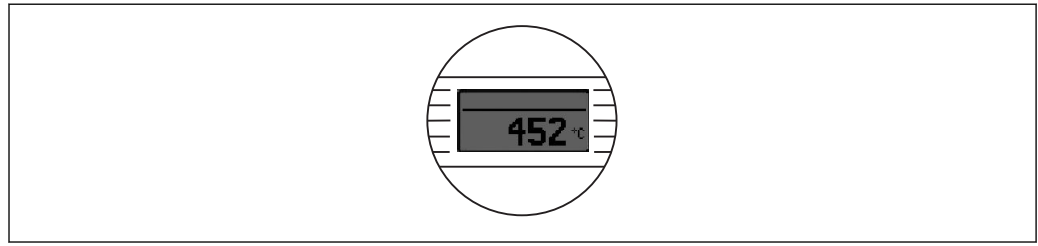
**Additional information***Value only*

A0014564

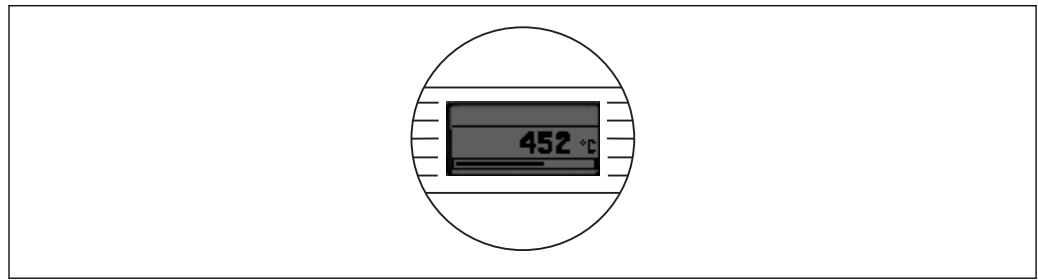
*Value + Bargraph*



A0014563

**Value 1 display****Navigation**

 Display/operation → Value 1 display  
 Expert → System → Display → Value 1 display

**Description**

Use this function to select one of the measured values to be shown on the local display.

 The **Format display** parameter is used to specify how the measured values are displayed (→  47).

**Options:**

- Process value
- Sensor 1
- Sensor 2
- Output current
- Percent of range
- Device temperature

**Factory settings**

Process value

**Decimal places 1****Navigation**

 Display/operation → Decimal places 1  
 Expert → System → Display → Decimal places 1

**Prerequisite**

A measured value is specified in the **Value 1 display** parameter (→  48).





<b>Description</b>	Use this function to select the number of decimal places displayed for the display value. This setting does not affect the accuracy of the device for measuring or calculating the value.  If <b>Automatic</b> is selected, the maximum possible number of decimal places is always shown on the display.
<b>Options:</b>	<ul style="list-style-type: none"> <li>■ x</li> <li>■ x.x</li> <li>■ x.xx</li> <li>■ x.xxx</li> <li>■ x.xxxx</li> <li>■ Automatic</li> </ul>
<b>Factory settings</b>	Automatic

---

### Value 2 display



---

<b>Navigation</b>	 Display/operation → Value 2 display Expert → System → Display → Value 2 display
<b>Description</b>	Use this function to select one of the measured values to be shown on the local display.  The <b>Format display</b> parameter is used to specify how the measured values are displayed .
<b>Options:</b>	<ul style="list-style-type: none"> <li>■ Off</li> <li>■ Process value</li> <li>■ Sensor 1</li> <li>■ Sensor 2</li> <li>■ Output current</li> <li>■ Percent of range</li> <li>■ Device temperature</li> </ul>
<b>Factory settings</b>	Off

---

### Decimal places 2

---

<b>Navigation</b>	 Display/operation → Decimal places 2 Expert → System → Display → Decimal places 2
<b>Prerequisite</b>	A measured value is specified in the <b>Value 2 display</b> parameter.
<b>Description</b>	Use this function to select the number of decimal places displayed for the display value. This setting does not affect the accuracy of the device for measuring or calculating the value.  If <b>Automatic</b> is selected, the maximum possible number of decimal places is always shown on the display.

- Options:**
- x
  - x.x
  - x.xx
  - x.xxx
  - x.xxxx
  - Automatic

**Factory settings** Automatic

### Value 3 display

**Navigation**  Display/operation → Value 3 display  
Expert → System → Display → Value 3 display

**Description** Use this function to select one of the measured values to be shown on the local display.  
 The **Format display** parameter is used to specify how the measured values are displayed.

- Options:**
- Off
  - Process value
  - Sensor 1
  - Sensor 2
  - Output current
  - Percent of range
  - Device temperature

**Factory settings** Off

### Decimal places 3

**Navigation**  Display/operation → Decimal places 3  
Expert → System → Display → Decimal places 3

**Prerequisite** A measured value is specified in the **Value 3 display** parameter.

**Description** Use this function to select the number of decimal places displayed for the display value. This setting does not affect the accuracy of the device for measuring or calculating the value.  
 If **Automatic** is selected, the maximum possible number of decimal places is always shown on the display.





- Options:**
- x
  - x.x
  - x.xx
  - x.xxx
  - x.xxxx
  - Automatic

**Factory settings** Automatic

## 13.2 "Setup" menu

This menu contains all the parameters that are needed to configure the basic settings of the device. The transmitter can be put into operation with this limited parameter set.

 n = Stands for the number of sensor inputs (1 and 2)

Unit	
<b>Navigation</b>	 Setup → Unit Expert → System → Unit
<b>Description</b>	Use this function to select the engineering unit for all the measured values.
<b>Options:</b>	<ul style="list-style-type: none"> <li>■ °C</li> <li>■ °F</li> <li>■ K</li> <li>■ °R</li> <li>■ Ohm</li> <li>■ mV</li> </ul>
<b>Factory settings</b>	°C
Sensor type n	
<b>Navigation</b>	 Setup → Sensor type n Expert → Sensor → Sensor n → Sensor type n
<b>Description</b>	<p>Use this function to select the sensor type for the sensor input in question.</p> <ul style="list-style-type: none"> <li>■ Sensor type 1: settings for sensor input 1</li> <li>■ Sensor type 2: settings for sensor input 2</li> </ul> <p> Please observe the terminal assignment when connecting the individual sensors. In the case of 2-channel operation, the possible connection options also have to be observed.</p>
<b>Options:</b>	A list of all the possible sensor types is provided in the 'Technical data' section (→  33).
<b>Factory settings</b>	Sensor type 1: Pt100 IEC751 Sensor type 2: No sensor
Connection type n	
<b>Navigation</b>	 Setup → Connection type n Expert → Sensor → Sensor n → Connection type n
<b>Prerequisite</b>	An RTD sensor must be specified as the sensor type.
<b>Description</b>	Use this function to select the connection type for the sensor.

- Options:**
- Sensor 1 (connection type 1): 2-wire, 3-wire, 4-wire
  - Sensor 2 (connection type 2): 2-wire, 3-wire

- Factory settings**
- Sensor 1 (connection type 1): 4-wire
  - Sensor 2 (connection type 2): 3-wire

### 2-wire compensation n

- Navigation**  Setup → 2-wire compensation n  
Expert → Sensor → Sensor n → 2-wire compensation n

**Prerequisite** An RTD sensor with a **2-wire** connection type must be specified as the sensor type.

**Description** Use this function to specify the resistance value for two-wire compensation in RTDs.

**User input** 0 to 30 Ohm

**Factory settings** 0

### Reference junction n

- Navigation**  Setup → Reference junction n  
Expert → Sensor → Sensor n → Reference junction n

**Prerequisite** A thermocouple (TC) sensor must be selected as the sensor type.

**Description** Use this function to select reference junction measurement for temperature compensation of thermocouples (TC).

-  ■ If **Fixed value** is selected, the compensation value is specified via the **RJ preset value** parameter.
- Temperature measurement must be configured for channel 2 if **Sensor 2 value** is selected.

- Options:**
- No compensation: no temperature compensation is used.
  - Internal measurement: the internal reference junction temperature is used.
  - Fixed value: a fixed preset value is used.
  - Sensor 2 value: the measured value of sensor 2 is used.

 It is not possible to select the **Sensor 2 value** option for the **Reference junction 2** parameter.

**Factory settings** Internal measurement



### RJ preset value n

<b>Navigation</b>	 Setup → RJ preset value Expert → Sensor → Sensor n → RJ preset value
<b>Prerequisite</b>	The <b>Fixed value</b> parameter must be set if the <b>Reference junction n</b> option is selected.
<b>Description</b>	Use this function to define the fixed preset value for temperature compensation.
<b>User input</b>	-50 to +85 °C
<b>Factory settings</b>	0.00

---

### Assign current output (PV)



---



<b>Navigation</b>	 Setup → Assign current output (PV) Expert → Communication → HART output → Assign current output (PV)
<b>Description</b>	Use this function to assign a measured variable to the primary HART® value (PV).
<b>Options:</b>	<ul style="list-style-type: none"> <li>■ Sensor 1 (measured value)</li> <li>■ Sensor 2 (measured value)</li> <li>■ Average of the two measured values: <math>0.5 \times (SV1+SV2)</math></li> <li>■ Difference between sensor 1 and sensor 2: <math>SV1-SV2</math></li> <li>■ Sensor 1 (backup sensor 2): If sensor 1 fails, the value of sensor 2 automatically becomes the primary HART® value (PV); sensor 1 (OR sensor 2)</li> <li>■ Sensor switching: If the value exceeds the configured threshold value T for sensor 1, the measured value of sensor 2 becomes the primary HART® value (PV). The system switches back to sensor 1 when the measured value of sensor 1 is at least 2 K below T: sensor 1 (sensor 2, if sensor 1 &gt; T)</li> <li>■ Average: <math>0.5 \times (SV1+SV2)</math> with backup (measured value of sensor 1 or sensor 2 in the event of a sensor error in the other sensor)</li> </ul> <p> The threshold value can be set with the <b>Sensor switch set point</b> (→  58) parameter. With temperature-dependent switching, it is possible to combine 2 sensors that offer advantages in different temperature ranges.</p>
<b>Factory settings</b>	Sensor 1

---

### Lower range value

---

<b>Navigation</b>	 Setup → Lower range value Expert → Output → Lower range value
<b>Description</b>	Use this function to assign a measured value to the current value 4 mA.   The set point that can be set depends on the sensor type used in the <b>Sensor type</b> (→  51) parameter and the measured variable assigned in the <b>Assign current output (PV)</b> parameter.
<b>User input</b>	Depends on the sensor type and the setting for "Assign current output (PV)."
<b>Factory settings</b>	0

<b>Upper range value</b>	
<b>Navigation</b>	 Setup → Upper range value Expert → Output → Upper range value
<b>Description</b>	Use this function to assign a measured value to the current value 20 mA.  The set point that can be set depends on the sensor type used in the <b>Sensor type</b> (→  51) parameter and the measured variable assigned in the <b>Assign current output (PV)</b> parameter.
<b>User input</b>	Depends on the sensor type and the setting for "Assign current output (PV)."
<b>Factory settings</b>	100

### 13.2.1 "Advanced setup" submenu

#### Corrosion monitoring

Sensor connection cable corrosion can lead to false measured value readings. Therefore the unit offers the possibility of recognizing any corrosion before a measured value is affected. Corrosion monitoring is only possible for RTDs with a 4-wire connection and thermocouples.

#### Drift/difference mode

If two sensors are connected and the measured values differ by a specified value, a status signal is generated as a diagnostic event. The drift/difference mode can be used to verify the correctness of the measured values and for mutual monitoring of the connected sensors. The drift/difference mode is enabled with the **Drift/difference mode** parameter. A distinction is made between two specific modes. If the **In band** option is selected ( $ISV1-SV2I < \text{drift/difference set point}$ ), a status message is output if the value drops below the set point, or if the value exceeds the set point if the **Out band (drift)** option is selected ( $ISV1-SV2I > \text{drift/difference set point}$ ).

*Procedure for configuring the drift/difference mode*

1. Start
↓
2. For drift/difference monitoring, select <b>Out band</b> for drift detection and <b>In band</b> for difference monitoring.
↓
3. Set the alarm category for drift/difference monitoring to <b>Out of specification (S)</b> , <b>Maintenance required (M)</b> or <b>Failure (F)</b> as required.
↓
4. Set the set point for drift/difference monitoring to the desired value.
↓
5. End

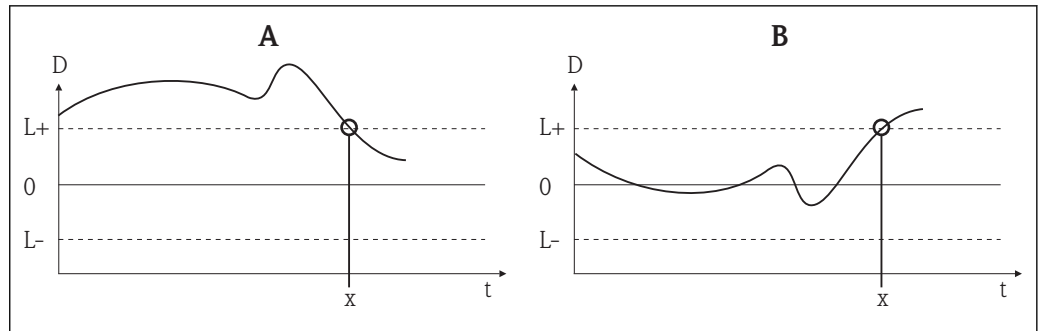

A0014782

13 Drift/difference mode

A Value under range

B Value over range

D Drift

L+, Upper (+) or lower (-) set point

L-

t Time

x Diagnostics event, status signal is generated

## Enter access code

### Navigation

Setup → Advanced setup → Enter access code  
Expert → Enter access code

### Description

Use this function to enable the service parameters via the operating tool. If an incorrect access code is entered, the user retains his current access authorization.

**i** If a value is entered that is not equal to the access code, the parameter is automatically set to **0**. The service parameters should only be modified by the service organization.

### User input

0 to 9 999

### Factory settings

0

## Access status tooling

### Navigation

Setup → Advanced setup → Access status tooling  
Expert → Access status tooling

### Description

Use this function to show access authorization to the parameters.

### Additional information

If additional write protection is active, this restricts the current access authorization even further. The write protection status can be viewed via the **Locking status** parameter.

### Options:

- Operator
- Service

### Factory settings

Operator

---

**Device temperature alarm**





---

<b>Navigation</b>	 Setup → Advanced setup → Device temperature alarm
<b>Description</b>	Use this function to select the category (status signal) as to how the device reacts when the electronics temperature of the transmitter exceeds or falls below the limit value < -40 °C (-40 °F) or > +85 °C (+185 °F).
<b>Options:</b>	<ul style="list-style-type: none"> <li>■ Off</li> <li>■ Out of specification (S)</li> <li>■ Failure (F)</li> </ul>
<b>Factory settings</b>	Out of specification (S)

---

**Device tag**



---

<b>Navigation</b>	 Setup → Advanced setup → Device tag Diagnostics → Device information → Device tag Expert → Diagnostics → Device information → Device tag
<b>Description</b>	Use this function to enter a unique name for the measuring point so it can be identified quickly within the plant. The name is displayed in the header of the plug-in display. (→  9,  20)
<b>User input</b>	Max. 32 characters, such as letters, numbers or special characters (e.g. @, %, /)
<b>Factory settings</b>	-none-

---

**Locking status**

---

<b>Navigation</b>	 Setup → Advanced setup → Locking status Expert → Locking status
<b>Description</b>	Use this function to view the device locking status. The DIP switch for hardware locking is fitted on the display module. When write protection is activated, write access to the parameters is disabled. (→  20)



## "Sensor" submenu

---

### Sensor offset n

---

 n = Stands for the number of sensor inputs (1 and 2)

#### Navigation

 Setup → Advanced setup → Sensor → Sensor offset n  
Expert → Sensor → Sensor n → Sensor offset n

#### Description

Use this function to set the zero point correction (offset) of the sensor measured value. The value indicated is added to the measured value.

#### User input

-10.0...+10.0

#### Factory settings

0.0

---

### Corrosion detection

---

#### Navigation

 Setup → Advanced setup → Sensor → Corrosion detection  
Expert → Sensor → Diagnostic settings → Corrosion detection

#### Description

Use this function to select the category (status signal) which is displayed when corrosion of the sensor connection cables is detected.

 Only possible for RTD sensors with 4-wire connection and thermocouples (TC).

#### Options:

- Maintenance required (M)
- Failure (F)

#### Factory settings

Maintenance required (M)

---

### Drift/difference mode

---

#### Navigation

 Setup → Advanced setup → Sensor → Drift/difference mode  
Expert → Sensor → Diagnostic settings → Drift/difference mode

#### Description

Use this function to choose whether the device reacts to the value exceeding or dropping below the drift/difference set point.

 Can only be selected for 2-channel operation.

#### Additional information

- If the **Out band (drift)** option is selected, a status signal is displayed if the absolute value for the differential value exceeds the drift/difference set point.
- If the **In band** option is selected, a status signal is displayed if the absolute value for the differential value drops below the drift/difference set point.

- Options:**
- Off
  - Out band (drift)
  - In band

**Factory settings** Off

---

### Drift/difference alarm category

---

**Navigation**  Setup → Advanced setup → Sensor → Drift/difference alarm category  
Expert → Sensor → Diagnostic settings → Drift/difference alarm category

**Prerequisite** The **Drift/difference mode** parameter must be activated with the **Out band (drift)** or **In band** option.

**Description** Use this function to select the category (status signal) as to how the device reacts when a drift/difference is detected between sensor 1 and sensor 2.

- Options:**
- Out of specification (S)
  - Maintenance required (M)
  - Failure (F)

**Factory settings** Maintenance required (M)

---

### Drift/difference set point

---

**Navigation**  Setup → Advanced setup → Sensor → Drift/difference set point  
Expert → Sensor → Diagnostic settings → Drift/difference set point

**Prerequisite** The **Drift/difference mode** parameter must be activated with the **Out band (drift)** or **In band** option.

**Description** Use this function to configure the maximum permissible measured value deviation between sensor 1 and sensor 2 which results in drift/difference detection.

**Options:** 1.0...999.0

**Factory settings** 999.0

---

### Sensor switch set point

---

**Navigation**  Setup → Advanced setup → Sensor → Sensor switch set point  
Expert → Sensor → Diagnostic settings → Sensor switch set point

**Description** Use this function to set the threshold value for sensor switching (→  53).

<b>Additional information</b>	The threshold value is relevant if the sensor switching function is assigned to a HART® variable (PV, SV, TV, QV).
<b>Options:</b>	Depends on the sensor types selected.
<b>Factory settings</b>	0.0 °C

### "Current output" submenu

#### Adjustment of the analog output (4 and 20 mA current trimming)

Current trimming is used to compensate the analog output (D/A conversion). Here, the output current of the transmitter can be adapted so that it suits the value expected at the higher-order system.

#### NOTICE

**Current trimming does not affect the digital HART® value. This can cause the measured value shown on the plug-in display to differ from the value displayed in the higher-order system.**

- ▶ The digital measured values can be adapted with the sensor trimming parameter in the menu Expert → Sensor → Sensor trimming.

#### Procedure

1. Start
⇓
2. Install an accurate amperemeter (more accurate than the transmitter) in the current loop.
⇓
3. Switch on current output simulation and set the simulation value to 4 mA.
⇓
4. Measure the loop current with the amperemeter and make a note of the value.
⇓
5. Set the simulation value to 20 mA.
⇓
6. Measure the loop current with the amperemeter and make a note of the value.
⇓
7. Enter the current values determined as adjustment values in the <b>Current trimming 4 mA / 20 mA</b> parameters.
⇓
8. End

---

## Output current

---

<b>Navigation</b>	 Setup → Advanced setup → Current output → Output current Expert → Output → Output current
<b>Description</b>	Use this function to view the calculated output current in mA.

---

**Measuring mode**



---

<b>Navigation</b>	 Setup → Advanced setup → Current output → Measuring mode Expert → Output → Measuring mode
<b>Description</b>	Enables the inversion of the output signal.
<b>Additional information</b>	<ul style="list-style-type: none"> <li>■ <b>Standard</b> The output current increases with increasing temperatures</li> <li>■ <b>Inverse</b> The output current decreases with increasing temperatures</li> </ul>
<b>Options:</b>	<ul style="list-style-type: none"> <li>■ Standard</li> <li>■ Inverse</li> </ul>
<b>Factory settings</b>	Standard

---

**Out of range category**



---

<b>Navigation</b>	 Setup → Advanced setup → Current output → Out of range category Expert → Output → Out of range category
<b>Description</b>	Use this function to select the category (status signal) as to how the device reacts when the value is outside the set measuring range.
<b>Options:</b>	<ul style="list-style-type: none"> <li>■ Out of specification (S)</li> <li>■ Maintenance required (M)</li> <li>■ Failure (F)</li> </ul>
<b>Factory settings</b>	Maintenance required (M)

---

**Failure mode**



---

<b>Navigation</b>	 Setup → Advanced setup → Current output → Failure mode Expert → Output → Failure mode
<b>Description</b>	Use this function to select the signal on alarm level of the current output in the event of an error.
<b>Additional information</b>	If <b>Max.</b> is selected, the signal on alarm level is specified using the <b>Failure current</b> parameter.
<b>Options:</b>	<ul style="list-style-type: none"> <li>■ Min.</li> <li>■ Max.</li> </ul>
<b>Factory settings</b>	Max.

---

**Failure current**



---

<b>Navigation</b>	 Setup → Advanced setup → Current output → Failure current Expert → Output → Failure current
<b>Prerequisite</b>	The <b>Max.</b> option is enabled in the <b>Failure mode</b> parameter.
<b>Description</b>	Use this function to set the value the current output adopts in an alarm condition.
<b>User input</b>	21.5 to 23.0 mA
<b>Factory settings</b>	22.5

---

**Current trimming 4 mA**



---

<b>Navigation</b>	 Setup → Advanced setup → Current output → Current trimming 4 mA Expert → Output → Current trimming 4 mA
<b>Description</b>	Use this function to set the correction value for the current output at the start of the measuring range at 4 mA (→  59).
<b>User input</b>	3.85 to 4.15 mA
<b>Factory settings</b>	4 mA

---

**Current trimming 20 mA**

---

<b>Navigation</b>	 Setup → Advanced setup → Current output → Current trimming 20 mA Expert → Output → Current trimming 20 mA
<b>Description</b>	Use this function to set the correction value for the current output at the end of the measuring range at 20 mA (→  59).
<b>User input</b>	19.850 to 20.15 mA
<b>Factory settings</b>	20.000 mA

### 13.3 "Diagnostics" menu

All the information that describes the device, the device status and the process conditions can be found in this group.

---

#### Actual diagnostics 1

---

<b>Navigation</b>	 Diagnostics → Actual diagnostics Expert → Diagnostics → Actual diagnostics 1
<b>Description</b>	Use this function to display the current diagnostics message. If two or more messages occur simultaneously, the message with the highest priority is shown on the display.
<b>Display</b>	Symbol for event behavior and diagnostic event.
<b>Additional information</b>	Example for display format: F261-Electronic modules

---

#### Remedy information

---

<b>Navigation</b>	 Diagnostics → Remedy information Expert → Diagnostics → Remedy information
<b>Description</b>	Use this function to display the remedial action to be taken for the current diagnostics message.

---

#### Previous diagnostics 1

---

<b>Navigation</b>	 Diagnostics → Previous diagnostics 1 Expert → Diagnostics → Previous diagnostics 1
<b>Description</b>	Use this function to display the last diagnostics message with the highest priority.
<b>Display</b>	Symbol for event behavior and diagnostic event.
<b>Additional information</b>	Example for display format: F261-Electronic modules

---

#### Operating time

---

<b>Navigation</b>	 Diagnostics → Operating time Expert → Diagnostics → Operating time
<b>Description</b>	Use this function to display the length of time the device has been in operation up to now.

**Display** Hours (h)

### 13.3.1 "Diagnostics list" submenu

Up to 3 diagnostics messages currently pending are displayed in this submenu. If more than 3 messages are pending, the messages with the highest priority are shown on the display. Information on diagnostics measures in the device and an overview of all the diagnostics message (→  27).

---

#### Actual diagnostics count

---

**Navigation**  Diagnostics → Diagnostics list → Actual diagnostics count  
Expert → Diagnostics → Diagnostics list → Actual diagnostics count

**Description** Use this function to display the number of diagnostics messages currently pending in the device.

---

#### Actual diagnostics

---

**Navigation**  Diagnostics → Diagnostics list → Actual diagnostics  
Expert → Diagnostics → Diagnostics list → Actual diagnostics

**Description** Use this function to display the current diagnostics messages with the highest priority to the third-highest priority.

**Display** Symbol for event behavior and diagnostic event.

**Additional information** Example for display format:  
F261-Electronic modules

---

#### Actual diag channel

---

**Navigation**  Diagnostics → Diagnostics list → Actual diag channel  
Expert → Diagnostics → Diagnostics list → Actual diag channel

**Description** Use this function to display the sensor input to which the diagnostics message refers.

**Display**

- Sensor 1
- Sensor 2
- -----

### 13.3.2 "Event logbook" submenu

---

#### Previous diagnostics n

---

 n = Number of diagnostics messages (n = 1 to 5)

#### Navigation

 Diagnostics → Diagnostics list → Previous diagnostics n  
Expert → Diagnostics → Diagnostics list → Previous diagnostics n

#### Description

Use this function to display the diagnostics messages that occurred in the past. The last 5 messages are listed in chronological order.

#### Display

Symbol for event behavior and diagnostic event.

#### Additional information

Example for display format:  
F261-Electronic modules

---

#### Previous diag channel

---

#### Navigation

 Diagnostics → Diagnostics list → Previous diag channel  
Expert → Diagnostics → Diagnostics list → Previous diag channel

#### Description

Use this function to display the possible sensor input to which the diagnostics message refers.

#### Display

- Sensor 1
- Sensor 2
- -----



### 13.3.3 "Device information" submenu

---

#### Device tag (→ 56)

---



---

#### Serial number

---

**Navigation**

 Diagnostics → Device information → Serial number  
Expert → Diagnostics → Device information → Serial number

**Description**

Use this function to display the serial number of the device. It can also be found on the nameplate.

**Display**

Max. 11-digit character string comprising letters and numbers

---

#### Firmware Version

---

**Navigation**

 Diagnostics → Device information → Firmware version  
Expert → Diagnostics → Device information → Firmware version

**Description**

Use this function to view the device firmware version installed.

**Display**

Max. 6-digit character string in the format xx.yy.zz

---

#### Device name

---

**Navigation**

 Diagnostics → Device information → Device name  
Expert → Diagnostics → Device information → Device name

**Description**

Use this function to display the device name. It can also be found on the nameplate.

---

#### Order code

---

**Navigation**

 Diagnostics → Device information → Order code  
Expert → Diagnostics → Device information → Order code

**Description** Use this function to display the order code of the device. It can also be found on the nameplate. The order code is generated from the extended order code, which defines all the device features of the product structure. In contrast, the device features cannot be read directly from the order code.



**Uses of the order code**

- To order an identical spare device.
- To identify the device quickly and easily, e.g. when contacting the supplier.

---

### Configuration counter

---

**Navigation**  Diagnostics → Device information → Configuration counter  
Expert → Diagnostics → Device information → Configuration counter

**Description** Use this function to display the counter reading for changes to device parameters.

 Static parameters, whose values change during optimization or configuration, cause this parameter to increment by 1. This supports parameter version management. If several parameters change, e. g. due to loading of parameters from FieldCare, etc. in the device, the counter can show a higher value. The counter can never be reset and is not reset to a default value after a device reset. If the counter overflows, (16 bit), it starts again at 1.

### 13.3.4 "Measured values" submenu

---

#### Sensor n value

---



n = Stands for the number of sensor inputs (1 and 2)

**Navigation**  Diagnostics → Measured values → Sensor n value  
Expert → Diagnostics → Measured values → Sensor n value

**Description** Use this function to display the current measured value at the sensor input.

---

#### Device temperature

---

**Navigation**  Diagnostics → Measured values → Device temperature  
Expert → Diagnostics → Measured values → Device temperature

**Description** Use this function to display the current electronics temperature.

### "Min/max values" submenu

---

#### Sensor n min value

---

 n = Stands for the number of sensor inputs (1 and 2)

#### Navigation

 Diagnostics → Measured values → Min/max values → Sensor n min value  
Expert → Diagnostics → Measured values → Min/max values → Sensor n min value

#### Description

Use this function to display the minimum temperature measured in the past at sensor input 1 or 2 (peakhold indicator).

---

#### Sensor n max value

---

 n = Stands for the number of sensor inputs (1 and 2)

#### Navigation

 Diagnostics → Measured values → Min/max values → Sensor n max value  
Expert → Diagnostics → Measured values → Min/max values → Sensor n max value

#### Description

Use this function to display the maximum temperature measured in the past at sensor input 1 or 2 (maximum indicator).

---

#### Reset sensor min/max values

---

#### Navigation

 Diagnostics → Measured values → Min/max values → Reset sensor min/max values  
Expert → Diagnostics → Measured values → Min/max values → Reset sensor min/max values

#### Description

Reset the maximum indicators for the minimum and maximum temperatures measured at the sensor inputs.

#### Options:

- No
- Yes

#### Factory setting

No

---

#### Device temperature max.

---

#### Navigation

 Diagnostics → Measured values → Min/max values → Device temperature max.  
Expert → Diagnostics → Measured values → Min/max values → Device temperature max.

**Description** Use this function to display the maximum electronics temperature measured in the past (maximum indicator).

---

### Device temperature min.

---

**Navigation**  Diagnostics → Measured values → Min/max values → Device temperature min.  
Expert → Diagnostics → Measured values → Min/max values → Device temperature min.

**Description** Use this function to display the minimum electronics temperature measured in the past (maximum indicator).

---

### Reset device temp. min/max values

---

**Navigation**  Diagnostics → Measured values → Min/max values → Reset device temp. min/max values  
Expert → Diagnostics → Measured values → Min/max values → Reset device temp. min/max values

**Description** Resets the maximum indicators for the minimum and maximum electronic temperatures measured.

**Options:**

- No
- Yes

**Factory settings** No

## 13.3.5 "Simulation" submenu

---

### Simulation current output

---

**Navigation**  Diagnostics → Simulation → Simulation current output  
Expert → Diagnostics → Simulation → Simulation current output

**Description** Use this function to switch simulation of the current output on and off. The display alternates between the measured value and a diagnostics message of the "function check" category (C) while simulation is in progress.

**Display** Measured value display ↔ C491 (simulation current output)

**Options:**

- Off
- On

**Factory settings** Off

**Additional information** The simulation value is defined in the **Value current output** parameter.

---

### Value current output

---

**Navigation**  Diagnostics → Simulation → Value current output  
Expert → Diagnostics → Simulation → Value current output

**Additional information** The **Simulation current output** parameter must be set to **On**.

**Description** Use this function to set a current value for the simulation. In this way, users can verify the correct adjustment of the current output and the correct function of downstream switching units.

**User input** 3.59 to 23.0 mA

**Factory settings** 3.59 mA

### 13.3.6 "Device reset" submenu

---

### Device reset

---

**Navigation**  Diagnostics → Device reset → Device reset  
Expert → Diagnostics → Device reset → Device reset

**Description** Use this function to reset the device configuration - either entirely or in part - to a defined state.

**Options:**

- **Not active**  
No action is executed and the user exits the parameter.
- **To factory defaults**  
All the parameters are reset to the factory setting.
- **To delivery settings**  
All the parameters are reset to the order configuration. The order configuration can differ from the factory setting if customer-specific parameter values were defined when the device was ordered.
- **Restart device**  
The device is restarted but the device configuration remains unchanged.

**Factory settings** Not active

## 13.4 "Expert" menu

The parameter groups for the Expert setup contain all the parameters of the "Display/operation", "Setup" and "Diagnostics" operating menus, as well as other parameters that are solely reserved for experts.

### 13.4.1 "System" submenu

---

#### Damping

---

<b>Navigation</b>	 Expert → System → Damping
<b>Description</b>	Use this function to set the time constant for current output damping.
<b>User input</b>	0 to 120 s
<b>Factory settings</b>	0.00 s
<b>Additional information</b>	The current output reacts with an exponential delay to fluctuations in the measured value. The time constant of this delay is specified by this parameter. If a low time constant is entered, the current output reacts quickly to the measured value. On the other hand, if a high time constant is entered, the current output reaction is delayed.

---

#### Alarm delay

---

<b>Navigation</b>	 Expert → System → Alarm delay
<b>Description</b>	Use this function to set the delay time during which a diagnostics signal is suppressed before it is output.
<b>User input</b>	0 to 5 s
<b>Factory settings</b>	2 s

---

#### Mains filter

---

<b>Navigation</b>	 Expert → System → Mains filter
<b>Description</b>	Use this function to select the mains filter for A/D conversion.
<b>Options:</b>	<ul style="list-style-type: none"> <li>■ 50Hz</li> <li>■ 60Hz</li> </ul>
<b>Factory setting</b>	50Hz

---

**Device temperature alarm (→  56)**

---

**Navigation**  Expert → System → Device temperature alarm (parameter)

**"Display" submenu**

(→  47)

**13.4.2 "Sensor" submenu**

---

**Serial no. sensor**

---

**Navigation**  Expert → Sensor → Sensor n → Serial no. sensor

**Description** Use this function to enter the serial number of the connected sensor.

**User input** String with up to 12 characters consisting of numbers and/or text

**Factory settings** " " (no text)

**"Sensor 1/2" submenu**

 n = Stands for the number of sensor inputs (1 and 2)

---

**Sensor n lower limit**

---

**Navigation**  Expert → Sensor → Sensor n → Sensor n lower limit

**Description** Displays the minimum physical full scale value.

---

**Sensor n upper limit**

---

**Navigation**  Expert → Sensor → Sensor n → Sensor n upper limit

**Description** Displays the maximum physical full scale value.

*"Sensor trimming" submenu*

**Sensor error adjustment (sensor trimming)**

Sensor trimming is used to adapt the actual sensor signal to the linearization of the selected sensor type stored in the transmitter. Compared to sensor transmitter matching, sensor trimming only takes place at the start and end value and does not achieve the same level of accuracy.

 Sensor trimming does not adapt the measuring range. It is used to adapt the sensor signal to the linearization stored in the transmitter.

*Procedure*

1. Start
⇓
2. Set the <b>Sensor trimming</b> parameter to the <b>User trim settings</b> setting.
⇓
3. Using a water/oil bath or a furnace, bring the sensor connected to the transmitter to a known and stable temperature. A temperature which is close to the set start of the measuring range is recommended.
⇓
4. Enter the reference temperature for the value at the start of the measuring range for the <b>Sensor trimming lower value</b> parameter. Based on the difference between the predefined reference temperature and the temperature actually measured at the input, the transmitter internally calculates a correction factor which is now used to linearize the input signal.
⇓
5. Using a water/oil bath or furnace, bring the sensor connected to the transmitter to a known and stable temperature close to the set end of the measuring range.
⇓
6. Enter the reference temperature for the value at the end of the measuring range for the <b>Sensor trimming upper value</b> parameter.
⇓
7. End

---

**Sensor trimming**

---

**Navigation**

 Expert → Sensor → Sensor n → Sensor trimming → Sensor trimming

**Description**

Use this function to select the linearization method to be used for the connected sensor.

 The original linearization can be restored by resetting this parameter to the **Factory trim settings** option.

**Options:**

- Factory trim settings
- User trim settings

**Factory settings**

Factory trim settings

---

**Sensor trimming lower value**

---

**Navigation**

 Expert → Sensor → Sensor n → Sensor trimming → Sensor trimming lower value

**Prerequisite**

The **User trim settings** option is enabled in the **Sensor trimming** parameter (→  71).

**Description**

Lower point for linear characteristic calibration (this affects offset and slope).



<b>User input</b>	Depends on the selected sensor type and the assignment of the current output (PV).
<b>Factory settings</b>	-200 °C

---

### Sensor trimming upper value

---

<b>Navigation</b>	 Expert → Sensor → Sensor n → Sensor trimming → Sensor trimming upper value
<b>Prerequisite</b>	The <b>User trim settings</b> option is enabled in the <b>Sensor trimming</b> parameter.
<b>Description</b>	Upper point for linear characteristic calibration (this affects offset and slope).
<b>User input</b>	Depends on the selected sensor type and the assignment of the current output (PV).
<b>Factory settings</b>	850 °C

---

### Sensor trimming min span

---

<b>Navigation</b>	 Expert → Sensor → Sensor n → Sensor trimming → Sensor trimming min span
<b>Prerequisite</b>	The <b>User trim settings</b> option is enabled in the <b>Sensor trimming</b> parameter.
<b>Description</b>	Use this function to view the minimum possible span between the sensor trimming upper and lower value.

#### *"Linearization" submenu*

*Procedure for configuring a linearization using Callendar/Van Dusen coefficients from a calibration certificate.*

1. Start
⇓
2. <b>Assign current output (PV)</b> = set sensor 1 (measured value)
⇓
3. Select unit (°C).
⇓
4. Select the sensor type (linearization type) "RTD platinum (Callendar/Van Dusen)".
⇓
5. Select type of connection e.g. 3-wire.
⇓
6. Set the lower and upper sensor limits.
⇓
7. Enter the four coefficients A, B, C and R0.
⇓

8. If special linearization is also used for a second sensor, repeat steps 2 to 6.
⇓
9. End

---

### Sensor n lower limit

---

<b>Navigation</b>	 Expert → Sensor → Sensor n → Linearization → Sensor n lower limit
<b>Prerequisite</b>	The RTD platinum, RTD poly nickel or RTD polynomial copper option is enabled in the <b>Sensor type</b> parameter.
<b>Description</b>	Use this function to set the lower calculation limit for special sensor linearization.
<b>User input</b>	Depends on the sensor type selected.
<b>Factory settings</b>	-200 °C

---

### Sensor n upper limit

---

<b>Navigation</b>	 Expert → Sensor → Sensor n → Linearization → Sensor n upper limit
<b>Prerequisite</b>	The RTD platinum, RTD poly nickel or RTD polynomial copper option is enabled in the <b>Sensor type</b> parameter.
<b>Description</b>	Use this function to set the upper calculation limit for special sensor linearization.
<b>User input</b>	Depends on the sensor type selected.
<b>Factory settings</b>	850 °C

---

### Call./v. Dusen coeff. R0

---

<b>Navigation</b>	 Expert → Sensor → Sensor n → Linearization → Call./v. Dusen coeff. R0
<b>Prerequisite</b>	The RTD platinum (Callendar/Van Dusen) option is enabled in the <b>Sensor type</b> parameter.
<b>Description</b>	Use this function to set the R0 value for linearization with the Callendar/Van Dusen polynomial.
<b>User input</b>	40.000 to 1 050.000
<b>Factory settings</b>	100.000 Ohm

---

**Call./v. Dusen coeff. A, B and C**



---

<b>Navigation</b>	 Expert → Sensor → Sensor n → Linearization → Call./v. Dusen coeff. A, B, C
<b>Prerequisite</b>	The RTD platinum (Callendar/Van Dusen) option is enabled in the <b>Sensor type</b> parameter.
<b>Description</b>	Use this function to set the coefficients for sensor linearization based on the Callendar/Van Dusen method.
<b>Factory settings</b>	<ul style="list-style-type: none"> <li>■ A: 3.910000e-003</li> <li>■ B: -5.780000e-007</li> <li>■ C: -4.180000e-012</li> </ul>

---

**Polynomial coeff. R0**



---

<b>Navigation</b>	 Expert → Sensor → Sensor n → Linearization → Polynomial coeff. R0
<b>Prerequisite</b>	The RTD poly nickel or RTD polynomial copper option is enabled in the <b>Sensor type</b> parameter.
<b>Description</b>	Use this function to set the R0 value for linearization of nickel/copper sensors.
<b>User input</b>	40.000 to 1 050.000 Ohm
<b>Factory settings</b>	100.00 Ohm

---

**Polynomial coeff. A, B**

---

<b>Navigation</b>	 Expert → Sensor → Sensor n → Linearization → Polynomial coeff. A, B
<b>Prerequisite</b>	The RTD poly nickel or RTD copper polynomial option is enabled in the <b>Sensor type</b> parameter.
<b>Description</b>	Use this function to set the coefficients for sensor linearization of copper/nickel resistance thermometers.
<b>Factory settings</b>	Polynom coeff. A = 5.49630e-003 Polynom coeff. B = 6.75560e-006

**"Diagnostic settings" submenu**

---

**Calibration counter start**

---

<b>Navigation</b>	 Expert → Sensor → Diagnostic settings → Calibration counter start
-------------------	---

<b>Description</b>	Option to control the calibration counter.  <ul style="list-style-type: none"> <li>▪ The countdown duration (in days) is specified with the <b>Calibration counter start value</b> parameter.</li> <li>▪ The status signal issued when the limit value is reached is defined with the <b>Calibration counter alarm category</b> parameter.</li> </ul>
<b>Options:</b>	<ul style="list-style-type: none"> <li>▪ <b>Off:</b> Stops the calibration counter</li> <li>▪ <b>On:</b> Starts the calibration counter</li> <li>▪ <b>Reset + run:</b> Resets to the set start value and starts the calibration counter</li> </ul>
<b>Factory settings</b>	Off

---

### Calibration counter alarm category

---

<b>Navigation</b>	 Expert → Sensor → Diagnostic settings → Calibration counter alarm category
<b>Description</b>	Use this function to select the category (status signal) as to how the device reacts to the set calibration countdown.
<b>Options:</b>	<ul style="list-style-type: none"> <li>▪ Maintenance required (M)</li> <li>▪ Failure (F)</li> </ul>
<b>Factory settings</b>	Maintenance required (M)

---

### Calibration counter start value



---

<b>Navigation</b>	 Expert → Sensor → Diagnostic settings → Calibration counter start value
<b>Description</b>	Use this function to set the start value for the calibration counter.
<b>User input</b>	0 to 365 d (days)
<b>Factory settings</b>	365

---

### Calibration countdown

---

<b>Navigation</b>	 Expert → Sensor → Diagnostic settings → Calibration countdown
<b>Description</b>	Use this function to view the time remaining until the next calibration.  The countdown of the calibration counter is only running if the device is switched on. Example: The calibration counter is set to 365 days on January 1st, 2011. If the device will be switched off for 100 days, the calibration counter alarm is displayed on April 10th, 2012.

### 13.4.3 "Output" submenu

---

#### Measuring mode

---

<b>Navigation</b>	 Expert → Output → Measuring mode
<b>Description</b>	Enables the inversion of the output signal.
<b>Additional information</b>	<ul style="list-style-type: none"> <li>■ <b>Standard</b> The output current increases with increasing temperatures</li> <li>■ <b>Inverse</b> The output current decreases with increasing temperatures</li> </ul>
<b>Options:</b>	<ul style="list-style-type: none"> <li>■ Standard</li> <li>■ Inverse</li> </ul>
<b>Factory settings</b>	Standard

### 13.4.4 "Communication" submenu

#### "HART configuration" submenu

---

#### Device tag (→ 56)

---

<b>Navigation</b>	 Expert → Communication → HART configuration → Device tag
-------------------	--

---

#### HART short tag

---

<b>Navigation</b>	 Expert → Communication → HART configuration → HART short tag
<b>Description</b>	Use this function to define a short tag for the measuring point.
<b>User input</b>	Up to 8 alphanumeric characters (letters, numbers and special characters)
<b>Factory settings</b>	SHORTTAG

---

#### HART address

---

<b>Navigation</b>	 Expert → Communication → HART configuration → HART address
<b>Description</b>	Use this function to define the HART address of the device.

<b>User input</b>	<ul style="list-style-type: none"> <li>■ For a system in accordance with HART 5.0: 0 to 15</li> <li>■ For a system in accordance with HART 6.0: 0 to 63</li> </ul>
<b>Factory settings</b>	0
<b>Additional information</b>	The measured value can only be transmitted via the current value if the address is set to "0". The current is fixed at 4.0 mA for all other addresses (Multidrop mode).

---

### No. of preambles

---

<b>Navigation</b>	 Expert → Communication → HART configuration → No. of preambles
<b>Description</b>	Use this function to define the number of preambles in the HART telegram.
<b>User input</b>	2 ... 20
<b>Factory settings</b>	5

---

### Burst mode

---

<b>Navigation</b>	 Expert → Communication → HART configuration → Burst mode
<b>Description</b>	Use this function to switch the HART burst mode on or off.
<b>Options:</b>	<ul style="list-style-type: none"> <li>■ <b>Off</b> The device only sends data to the bus at the request of a HART master.</li> <li>■ <b>On</b> The device regularly sends data to the bus without being requested to do so.</li> </ul>
<b>Factory settings</b>	Off

---

### Burst command

---

<b>Navigation</b>	 Expert → Communication → HART configuration → Burst command
<b>Prerequisite</b>	This parameter can only be selected if the <b>Burst mode</b> option is enabled.
<b>Description</b>	Use this function to select the command whose response is sent to the HART master in the burst mode.

- Options:**
- Command 1  
Read out the primary variable
  - Command 2  
Read out the current and the main measured value as a percentage
  - Command 3  
Read out the dynamic HART variables and the current
  - Command 9  
Read out the dynamic HART variables including the related status
  - Command 33  
Read out the dynamic HART variables including the related unit

**Factory settings** Command 2

**Additional information** Commands 1, 2, 3 and 9 are universal HART commands.  
Command 33 is a "Common-Practice" HART command.  
More details on this are provided in the HART specifications.

---

### Burst variable slot n



---

 n = Number of burst variable slots (0 to 3)

**Navigation**  Expert → Communication → HART configuration → Burst variable slot n

**Prerequisite** This parameter can only be selected if the **Burst mode** option is enabled.

**Description** Use this function to assign a measured variable to slots 0 to 3.

 This assignment is **only** relevant for the burst mode. The measured variables are assigned to the 4 HART variables (PV, SV, TV, QV) in the **HART output** (→  82) menu.

- Options:**
- Sensor 1 (measured value)
  - Sensor 2 (measured value)
  - Device temperature
  - Average of the two measured values:  $0.5 \times (SV1+SV2)$
  - Difference between sensor 1 and sensor 2:  $SV1-SV2$
  - Sensor 1 (backup sensor 2): If sensor 1 fails, the value of sensor 2 automatically becomes the primary HART® value (PV); sensor 1 (OR sensor 2)
  - Sensor switching: If the value exceeds the configured threshold value T for sensor 1, the measured value of sensor 2 becomes the primary HART® value (PV). The system switches back to sensor 1 when the measured value of sensor 1 is at least 2 K below T: sensor 1 (sensor 2, if sensor 1 > T)

 The threshold value can be set with the **Sensor switch set point** parameter. With temperature-dependent switching, it is possible to combine 2 sensors that offer advantages in different temperature ranges.

Average:  $0.5 \times (SV1+SV2)$  with backup (measured value of sensor 1 or sensor 2 in the event of a sensor error in the other sensor)

- Factory settings**
- Burst variable slot 0: sensor 1
  - Burst variable slot 1: device temperature
  - Burst variable slot 2: sensor 1
  - Burst variable slot 3: sensor 1

---

**Configuration changed**

---

**Navigation**  Expert → Communication → HART configuration → Configuration changed

**Description** Indicates the change of configuration via a primary or a secondary master.

---

**Reset Configuration Changed Flag**

---

**Navigation**  Expert → Communication → HART configuration → Reset Configuration Changed Flag

**Description** Reset of the information **Configuration changed** via a primary or secondary master.

**"HART info" submenu**

---

**Device type**

---

**Navigation**  Expert → Communication → HART info → Device type

**Description** Use this function to view the device type with which the device is registered with the HART Communication Foundation. The device type is specified by the manufacturer. It is needed to assign the appropriate device description file (DD) to the device.

**Display** 2-digit hexadecimal number

**Factory settings** 0xcc

---

**Device revision**

---

**Navigation**  Expert → Communication → HART info → Device revision

**Description** Use this function to view the device revision with which the device is registered with the HART® Communication Foundation. It is needed to assign the appropriate device description file (DD) to the device.

---

**HART revision**

---

**Navigation**  Expert → Communication → HART info → HART revision

**Description** Use this function to display the HART revision of the device.



---

**HART descriptor**



---

<b>Navigation</b>	 Expert → Communication → HART info → HART descriptor
<b>Description</b>	Use this function to define a description for the measuring point.
<b>User input</b>	Up to 32 alphanumeric characters (letters, numbers and special characters)
<b>Factory settings</b>	The device name

---

**HART message**



---

<b>Navigation</b>	 Expert → Communication → HART info → HART message
<b>Description</b>	Use this function to define a HART message which is sent via the HART protocol when requested by the master.
<b>User input</b>	Up to 32 alphanumeric characters (letters, numbers and special characters)
<b>Factory settings</b>	The device name

---

**RevSW**



---

<b>Navigation</b>	 Expert → Communication → HART info → RevSW
<b>Description</b>	Use this function to display the software revision of the device.

---

**HART date code**

---



<b>Navigation</b>	 Expert → Communication → HART info → HART date code
<b>Description</b>	Use this function to define date information for individual use.
<b>User input</b>	Date in the format year-month-day (YYYY-MM-DD)
<b>Factory settings</b>	2010-01-01

## "HART output" submenu

---

### Assign current output (PV)

---

<b>Navigation</b>	 Expert → Communication → HART output → Assign current output (PV)
<b>Description</b>	Use this function to assign a measured variable to the primary HART value (PV).
<b>Options:</b>	<ul style="list-style-type: none"> <li>■ Sensor 1 (measured value)</li> <li>■ Sensor 2 (measured value)</li> <li>■ Device temperature</li> <li>■ Average of the two measured values: <math>0.5 \times (SV1+SV2)</math></li> <li>■ Difference between sensor 1 and sensor 2: <math>SV1-SV2</math></li> <li>■ Sensor 1 (backup sensor 2): If sensor 1 fails, the value of sensor 2 automatically becomes the primary HART® value (PV): sensor 1 (OR sensor 2)</li> <li>■ Sensor switching: If the value exceeds the configured threshold value T for sensor 1, the measured value of sensor 2 becomes the primary HART® value (PV). The system switches back to sensor 1 when the measured value of sensor 1 is at least 2 K below T: sensor 1 (sensor 2, if sensor 1 &gt; T)</li> <li>■ Average: <math>0.5 \times (SV1+SV2)</math> with backup (measured value of sensor 1 or sensor 2 in the event of a sensor error in the other sensor)</li> </ul> <p> The threshold value can be set with the <b>Sensor switch set point</b> parameter. With temperature-dependent switching, it is possible to combine 2 sensors that offer advantages in different temperature ranges.</p>
<b>Factory settings</b>	Sensor 1

---

### PV



---

<b>Navigation</b>	 Expert → Communication → HART output → PV
<b>Description</b>	Use this function to display the primary HART value.

---

### Assign SV

---

<b>Navigation</b>	 Expert → Communication → HART output → Assign SV
<b>Description</b>	Use this function to assign a measured variable to the secondary HART value (SV).
<b>Options:</b>	See <b>Assign current output (PV)</b> parameter, (→  82)
<b>Factory settings</b>	Device temperature

---

### SV

---

**Navigation**  Expert → Communication → HART output → SV

**Description** Use this function to display the secondary HART value.

---

### Assign TV

---

**Navigation**  Expert → Communication → HART output → Assign TV

**Description** Use this function to assign a measured variable to the tertiary HART value (TV).

**Options:** See **Assign current output (PV)** parameter, (→  82)

**Factory settings** Sensor 1

---

### TV

---

**Navigation**  Expert → Communication → HART output → TV

**Description** Use this function to display the tertiary HART value.

---

### Assign QV

---

**Navigation**  Expert → Communication → HART output → Assign QV

**Description** Use this function to assign a measured variable to the quaternary (fourth) HART value (QV).

**Options:** See **Assign current output (PV)** parameter, (→  82)

**Factory settings** Sensor 1

---

### QV

---

**Navigation**  Expert → Communication → HART output → QV

**Description** Use this function to display the quaternary (fourth) HART value.



## 13.4.5 "Diagnostics" submenu

### "Device information" submenu

---

#### Extended order code 1-3

---

<b>Navigation</b>	 Expert → Diagnostics → Device information → Extended order code 1-3
<b>Description</b>	Use this function to display the first, second and/or third part of the extended order code. On account of length restrictions, the extended order code is split into a maximum of 3 parameters. The extended order code indicates the version of all the features of the product structure for the device and thus uniquely identifies the device. It can also be found on the nameplate.
	 <b>Uses of the extended order code</b> <ul style="list-style-type: none"> <li>■ To order an identical spare device.</li> <li>■ To check the ordered device features against the shipping note.</li> </ul>

---

#### ENP-version

---

<b>Navigation</b>	 Expert → Diagnostics → Device information → ENP version
<b>Description</b>	Use this function to display the version of the electronic nameplate (ENP).
<b>Display</b>	6-digit number in the format xx.yy.zz

---

#### Device revision

---

<b>Navigation</b>	 Expert → Diagnostics → Device information → Device revision Expert → Communication → HART info → Device revision
<b>Description</b>	Use this function to view the device revision with which the device is registered with the HART Communication Foundation. It is needed to assign the appropriate device description file (DD) to the device.
<b>Display</b>	2-digit hexadecimal number

---

#### Manufacturer ID

---

<b>Navigation</b>	 Expert → Diagnostics → Device information → Manufacturer ID
<b>Description</b>	Use this function to view the manufacturer ID with which the device is registered with the HART Communication Foundation.
<b>Display</b>	2-digit hexadecimal number

**Factory settings** 17

---

### Manufacturer

---

**Navigation**  Expert → Diagnostics → Device information → Manufacturer

**Description** Use this function to display the name of the manufacturer.

---

### Hardware revision

---

**Navigation**  Expert → Diagnostics → Device information → Hardware revision  
Expert → Communication → HART info → Hardware revision

**Description** Use this function to display the hardware revision of the device.

### "Measured values" submenu

---

### Sensor n raw value

---

 n = Stands for the number of sensor inputs (1 and 2)

**Navigation**  Expert → Diagnostics → Measured values → Sensor n raw value

**Description** Use this function to display the non-linearized mV/Ohm value at the specific sensor input.

# Index

- 0 ... 9**  
 2-wire compensation (parameter) . . . . . 52
- A**  
 Access status tooling (parameter) . . . . . 55  
 Actual diag channel . . . . . 63  
 Actual diagnostics . . . . . 63  
 Actual diagnostics 1 . . . . . 62  
 Actual diagnostics count . . . . . 63  
 Advanced setup (submenu) . . . . . 54  
 Alarm delay (parameter) . . . . . 70  
 Assign current output (PV) (parameter) . . . . . 53, 82  
 Assign QV (parameter) . . . . . 83  
 Assign SV (parameter) . . . . . 82  
 Assign TV (parameter) . . . . . 83
- B**  
 Burst command (parameter) . . . . . 78  
 Burst mode (parameter) . . . . . 78  
 Burst variable slot (parameter) . . . . . 79
- C**  
 Cable specification . . . . . 14  
 Calibration countdown . . . . . 76  
 Calibration counter alarm category (parameter) . . . . . 76  
 Calibration counter start (parameter) . . . . . 75  
 Calibration counter start value (parameter) . . . . . 76  
 Call./v. Dusen coeff. A, B and C (parameter) . . . . . 75  
 Call./v. Dusen coeff. R0 (parameter) . . . . . 74  
 Communication (submenu) . . . . . 77  
 Configuration changed (parameter) . . . . . 80  
 Configuration counter . . . . . 66  
 Connection combinations . . . . . 14  
 Connection type (parameter) . . . . . 51  
 Corrosion detection (parameter) . . . . . 57  
 Current output (submenu) . . . . . 59  
 Current trimming 4 mA (parameter) . . . . . 61  
 Current trimming 20 mA (parameter) . . . . . 61
- D**  
 Damping (parameter) . . . . . 70  
 Decimal places 1 (parameter) . . . . . 48  
 Decimal places 2 (parameter) . . . . . 49  
 Decimal places 3 (parameter) . . . . . 50  
 Designated use . . . . . 6  
 Device info (submenu) . . . . . 65, 84  
 Device name . . . . . 65  
 Device reset (parameter) . . . . . 69  
 Device reset (submenu) . . . . . 69  
 Device revision . . . . . 80, 84  
 Device tag (parameter) . . . . . 56, 65, 77  
 Device temperature . . . . . 66  
 Device temperature alarm (parameter) . . . . . 56, 71  
 Device temperature max. . . . . 67  
 Device temperature min. . . . . 68  
 Device type . . . . . 80  
 Diagnostic settings (menu) . . . . . 75
- Diagnostics (menu) . . . . . 62  
 Diagnostics (submenu) . . . . . 84  
 Diagnostics events  
   Diagnostic behavior . . . . . 29  
   Overview . . . . . 30  
   Status signals . . . . . 29  
 Diagnostics list (submenu) . . . . . 63  
 Display (submenu) . . . . . 71  
 Display interval (parameter) . . . . . 47  
 Display/operation (menu) . . . . . 47  
 Drift/difference alarm category (parameter) . . . . . 58  
 Drift/difference mode (parameter) . . . . . 57  
 Drift/difference set point (parameter) . . . . . 58
- E**  
 ENP-version . . . . . 84  
 Enter access code (parameter) . . . . . 55  
 Event logbook (submenu) . . . . . 64  
 Expert (menu) . . . . . 70  
 Extended order code . . . . . 84
- F**  
 Failure current (parameter) . . . . . 61  
 Failure mode (parameter) . . . . . 60  
 FieldCare  
   Function scope . . . . . 21  
 Firmware Version . . . . . 65  
 Format display (parameter) . . . . . 47
- H**  
 Hardware revision . . . . . 85  
 HART address (parameter) . . . . . 77  
 HART configuration (submenu) . . . . . 77  
 HART date code (parameter) . . . . . 81  
 HART descriptor (parameter) . . . . . 81  
 HART info (submenu) . . . . . 80  
 HART message (parameter) . . . . . 81  
 HART output (submenu) . . . . . 82  
 HART revision . . . . . 80  
 HART short tag (parameter) . . . . . 77  
 HART® protocol  
   Device variables . . . . . 23  
   Operating tools . . . . . 23  
   Version data for the device . . . . . 23
- I**  
 Installation point  
   Field housing . . . . . 8  
   Terminal head, flat face as per DIN 43729 . . . . . 8  
   Top-hat rail (DIN rail clip) . . . . . 8
- L**  
 Linearization (submenu) . . . . . 73  
 Locking status . . . . . 56  
 Lower range value (parameter) . . . . . 53

**M**

Mains filter (parameter) . . . . .	70
Manufacturer . . . . .	85
Manufacturer ID (parameter) . . . . .	84
Measured values (submenu) . . . . .	66, 85
Measuring mode (parameter) . . . . .	60, 77
Min/max values (submenu) . . . . .	67

**N**

Nameplate . . . . .	7
No. of preambles (parameter) . . . . .	78

**O**

Operating menu structure . . . . .	18
Operating time . . . . .	62
Operation options	
Local operation . . . . .	17
Operating tool . . . . .	17
Overview . . . . .	17
Order code . . . . .	65
Out of range category (parameter) . . . . .	60
Output (submenu) . . . . .	77
Output current . . . . .	59

**P**

Polynomial coeff. A, B (parameter) . . . . .	75
Polynomial coeff. R0 (parameter) . . . . .	75
Previous diag channel . . . . .	64
Previous diagnostics . . . . .	64
Previous diagnostics 1 . . . . .	62
PV . . . . .	82

**Q**

QV . . . . .	83
--------------	----

**R**

Reference junction (parameter) . . . . .	52
Remedy information . . . . .	62
Reset Configuration Changed Flag (parameter) . . . . .	80
Reset device temp. min/max values (parameter) . . . . .	68
Reset sensor min/max values (parameter) . . . . .	67
RevSW . . . . .	81
RJ preset value (parameter) . . . . .	52

**S**

Sensor (submenu) . . . . .	57, 71
Sensor 1/2 (submenu) . . . . .	71
Sensor lower limit . . . . .	71
Sensor lower limit (parameter) . . . . .	74
Sensor max. value . . . . .	67
Sensor min value . . . . .	67
Sensor offset (parameter) . . . . .	57
Sensor raw value . . . . .	85
Sensor switch set point (parameter) . . . . .	58
Sensor trimming (parameter) . . . . .	72
Sensor trimming (submenu) . . . . .	71
Sensor trimming lower value (parameter) . . . . .	72
Sensor trimming min span . . . . .	73
Sensor trimming upper value (parameter) . . . . .	73
Sensor type (parameter) . . . . .	51

Sensor upper limit . . . . .	71
Sensor upper limit (parameter) . . . . .	74
Sensor value . . . . .	66
Serial no. sensor (parameter) . . . . .	71
Serial number . . . . .	65
Setup (menu) . . . . .	51
Simulation (submenu) . . . . .	68
Simulation current output (parameter) . . . . .	68
SV . . . . .	82
System (submenu) . . . . .	70

**T**

Terminal assignment . . . . .	13
Troubleshooting	
Application error with RTD sensor connection . . . . .	27
Application error with TC sensor connection . . . . .	28
Checking the display . . . . .	27
General errors . . . . .	27
TV . . . . .	83

**U**

Unit (parameter) . . . . .	51
Upper range value (parameter) . . . . .	54

**V**

Value 1 display (parameter) . . . . .	48
Value 2 display (parameter) . . . . .	49
Value 3 display (parameter) . . . . .	50
Value current output (parameter) . . . . .	69



**pyromation**<sup>®</sup> .com

Pyromation, Inc.  
5211 Industrial Road  
Fort Wayne, IN 46825  
USA Tel: (260) 484-2580  
Fax: (260) 482-6805 or (800) 837-6805

[www.pyromation.com](http://www.pyromation.com)