

AN ISO 9001 REGISTERED COMPANY

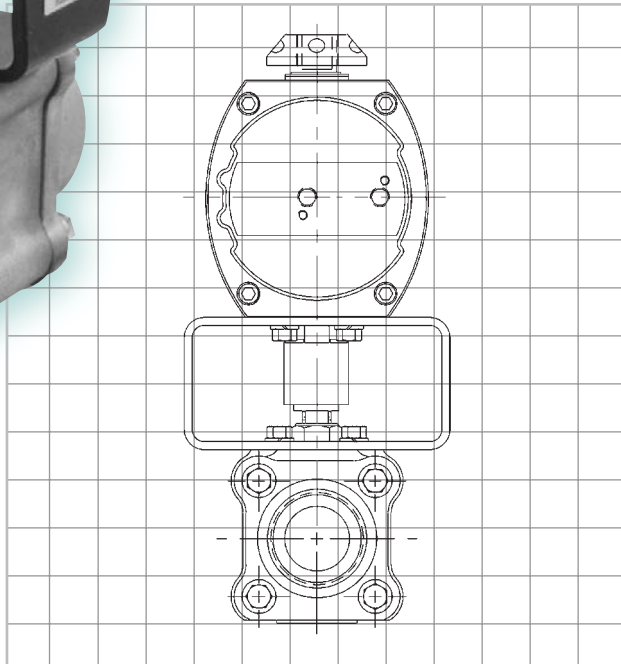

Series MP44 Ball Valves

High performance, high cycle, thermal shock-proof valves for automated curing and molding operations

Substantially Increase Your Molding Press Productivity with Worcester's MP44 High Performance Ball Valve

Worcester Controls, working with a leading tire manufacturer to solve chronic production problems, developed the MP44 valve for rubber and plastic molding operations. The criteria for the valve design were:

- Capable of handling steam to 300 psi.
- Capable of alternately handling steam, hot water, cold water, and hot nitrogen.
- Have bubble-tight shutoff.
- Be corrosion resistant to acidity and dirty steam.
- Operate dependably in a hot environment.
- Ease of installation and repair.
- Manual or automatic on-off and modulating control.
- Computer/PLC compatible.



The MP44 valve is all rotary. Its high cycle design meets all criteria and has passed every test and performance evaluation performed by many users. It is available with manual lever handles, or pneumatic or electric actuators for automatic on-off control.

The main design features include a heavy duty, self-adjusting stem seal assembly of Polyfill® and PEEK, Polyfill* and High-per Fill®* seats for steam to 470° F, 3-piece body design with screwed or weld end connection (eliminating the need for pipe union), swing-out center section for fast seat and seal replacement, heavy duty bolting to handle extreme thermal shock and stainless steel pipe ends to combat the effects of acid steam. The Series MP44 is a total molding press valve package.

Severe Service Options

The standard MP44 will operate in most steam/water environments with ease. If, however, the system contains abrasive materials such as excess boiler compound, pipe scale and dirt, Worcester recommends the optional hard nickel coated ball.

Trapped cavity pressure can occur when steam or hot gas is on one side of the valve and cold water is trapped inside the valve. If the water is heated, high pressure will occur with possible seat damage. To prevent this, Worcester recommends an optional (V3) upstream hole in the ball. The hole relieves excess pressure upstream.

A V48 extended lever handle is available to keep the handle cool and to permit full insulation of this valve.

Specifications

Valve Size: 1/4", 3/8", 1/2", 3/4", 1", 1 1/2", 2"
(1 1/4" available on application)

Style: 2-way (bi-directional flow) 3-piece construction.

Body Material: Forged carbon steel ASTM-A105.

Pipe End Material: 316 Stainless steel, ASTM-A351-CF8M (investment cast).

Ball: Stainless steel ASTM-A479-316 condition A.

Stem: 316 Stainless Steel ASTM-A479-316 condition A.

Body Bolts: ASTM-A193-GR-B7

Body Nuts: ASTM-A194-GR2H

Seats: 1-piece Polyfill (carbon, and graphite filled TFE), High-per Fill

Stem Seal: Two live-loaded polyfill seals and backup ring of PEEK (poly ether ether ketone).

Thrust Bearing: Polyfill with PEEK backup ring.

Body Seals: TFE coated 316 St. St. "S" gaskets

Temperature Range: -20°F to 500°F (Polyfill Seats)
-20°F to 600°F (High-per Fill Seats)

Maximum Pressure: 1500 psi CWP

Thermal Cycle Capability: Must operate to 250 psi saturated steam at 400°F, followed by cold water, and remain vacuum tight to 20 microns.

Design Specifications: ANSI B16.11 Socket weld and NPT screwed pipe ends, diameter and depth, threads to ANSI B1.20.1. ANSI B16.34 Body wall thickness, pressure temperature rating (600# class). NACE MRO, 1-75

Seat Seal Leakage: Bubble-tight

* Polyfill is an advanced Worcester seat material consisting of filled TFE (fillers are carbon and graphite). High-per Fill is available for steam pressures to 500 psi. High-per Fill is PEEK with glass and graphite fillers and has excellent abrasion resistance at elevated temperatures.

Dimensions inches (mm)

Standard Lever Handle

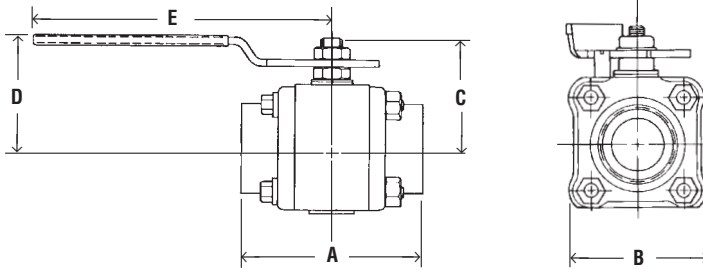

Extended Lever Handle

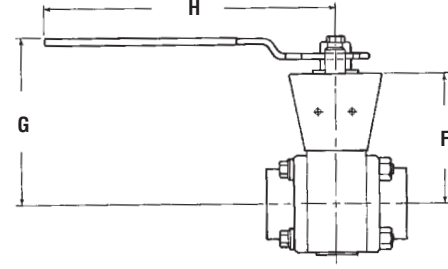

Manually Operated Valves - Lever Handle

Valve Size	Face to Face		Standard Lever Handle			Extended Lever Handle		
	A	B	C	D	E	F	G	H
1/4", 3/8", 1/2"	2.54 (64.5)	1.75 (44.5)	1.55 (39.4)	1.76 (44.7)	5.53 (140)	2.94 (74.7)	4.09 (104)	6.53 (166)
3/4"	2.76 (70.1)	2.00 (50.8)	1.64 (41.7)	1.86 (47.2)	5.53 (140)	3.03 (77.0)	4.20 (107)	6.53 (166)
1"	3.66 (93.0)	2.38 (60.5)	2.19 (55.6)	2.28 (57.9)	6.53 (165)	3.27 (83.1)	4.32 (110)	6.53 (166)
1 1/2"	4.50 (114)	3.16 (80.3)	2.88 (73.1)	2.83 (71.9)	8.03 (204)	4.23 (107)	5.37 (136)	8.03 (204)
2"	4.94 (126)	3.56 (90.4)	3.06 (77.7)	3.02 (76.7)	8.03 (204)	4.42 (112)	5.55 (141)	8.03 (204)

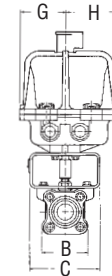
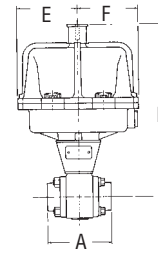
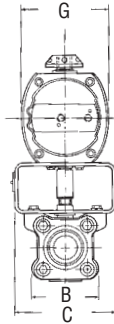
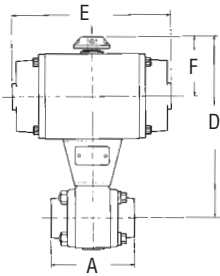

Automated On-Off Valves

Valve Size	Face to Face			39 Pneumatic Actuator					75 Electric Actuator					
	A	B	C	Size	D	E	F	G	Size	D	E	F	G	H
1/4", 3/8", 1/2"	2.54 (64.5)	1.75 (44.5)	4.00 (102)	10	2.11 (181)	6.10 (155)	2.48 (63)	3.02 (77)	10	11.4 (291)	3.90 (99)	3.90 (99)	3.14 (80)	3.61 (92)
				15	7.20 (183)	6.10 (155)	2.48 (63)	3.02 (77)	10	11.5 (293)	3.90 (99)	3.90 (99)	3.14 (80)	3.61 (92)
3/4"	2.76 (70.1)	2.00 (50.8)	4.00 (102)	10	7.92 (201)	7.66 (195)	2.84 (72)	3.70 (94)	10,12	11.8 (300)	3.90 (99)	3.90 (99)	3.14 (80)	3.61 (92)
				15	7.44 (190)	6.10 (155)	2.48 (63)	3.02 (77)						
1"	3.66 (93.0)	2.38 (60.5)	4.00 (102)	15	8.16 (207)	7.66 (195)	2.84 (72)	3.70 (94)	20,22	12.7 (323)	3.90 (99)	3.90 (99)	3.14 (80)	3.61 (92)
				20	9.12 (232)	7.66 (195)	2.84 (72)	3.70 (94)						
1 1/2"	4.50 (114)	3.16 (80.3)	5.00 (127)	25	11.69 (297)	10.62 (270)	4.07 (103)	5.34 (136)	20,22	12.9 (328)	3.90 (99)	3.90 (99)	3.14 (80)	3.61 (92)
				20	9.94 (252)	9.24 (235)	3.25 (83)	4.57 (116)						
2"	4.94 (126)	3.56 (90.4)	5.00 (127)	20	10.13 (257)	9.24 (235)	3.25 (83)	4.57 (116)	20,22	19.3 (490)	5.31 (135)	7.84 (199)	5.31 (135)	7.39 (188)
				25	11.88 (302)	10.62 (270)	4.07 (103)	5.34 (136)						
				30	12.70 (323)	12.77 (324)	4.48 (114)	6.10 (155)						

C_v Values and Equivalent Lengths of Pipe

Valve Size	C _v	Equivalent Length of Sched. 40 Pipe - Ft.
1/4", 3/8"	8	0.9
1/2"	8	3.1
3/4"	12	6.3
1"	32	3.1
1 1/2"	82	4.3
2"	120	7.5

Steam Ratings

Valve Size	Polyfill I		High-per Fill	
1/4", 3/8", 1/2"	450	459°F	500	470°F
3/4"	425	455°F	500	470°F
1"	400	447°F	500	470°F
1 1/2"	325	428°F	500	470°F
2"	300	424°F	500	470°F

** MP44 valves used on superheated steam may be used at any steam pressure provided the service temperature does not exceed the temperatures shown.

* Maximum valve pressure rating.

How to Order

Valve Size	Options	Product Series	Body Pipe Ends	Ball, Stem	Seat	Body Seal	End Connections		
1/4", 3/8", 1/2" 3/4" 1" 1 1/2" 2"	Blank - Built with lever handle B - No handle† E - No handle valve built for automation G - Stem grounding spring V - Vacuum Service Prep	MP44 - 3-piece body, standard port	4 - Carbon steel body, 316 stainless steel pipe ends	6 - 316 Stainless steel	P - Polyfill X - High-per Fill	M - TFE coated 316 stainless steel "S" gasket	SE - Screw pipe ends (NPT) NP - No pipe ends All IPS schedules of aluminum, stainless steel, carbon steel and alloy steel pipe S.P.S. copper pipe and red brass pipe.		

The ordering code above depicts a 1/2" MP44 valve with carbon steel body, stainless steel pipe ends, stainless steel ball and stem, Polyfill seals, stainless steel "S" body seals and screwed end connections.

**Variations (V-numbers):

- Listing of V-Number descriptions, leave blank if none.
- V3 - Upstream Relief Hole
 - V5 - Hydrostatic Testing
 - V6 - Source Inspection
 - V32 - Oval Handle
 - V36 - Certificate of Compliance
 - V37 - Certificate of Compliance & Hydro Testing
 - V46 - Silicon Free Lubricant
 - V48 - Extended Lever Handle
 - V58 - B16.34 Compliance
 - V59 - Extended Oval Handle
 - V60 - OSHA Lockout
 - V66 - Certificate of Compliance, European Valve Orders
 - V72 - Cert. of Compliance for European Pressure Equipment Directive Conformance

† To order an MP 44 Valve with 39 or 75 actuator, use prefix ordering code "B".

Worcester® is a registered trademark of Worcester Controls. • Worcester Controls® is a registered trademark of Flowserve Corporation. • Flowserve® is a registered trademark of Flowserve Corporation. • Polyfill® is a registered trademark of Worcester Controls. • High-per Fill® is a registered trademark of Worcester Controls.

Caution: Ball Valves can retain pressurized media in the body cavity when closed. Use care when disassembling. Always open valve to relieve pressure prior to disassembly.

Flowserve Corporation has established industry leadership in the design and manufacture of its products. When properly selected, this Flowserve product is designed to perform its intended function safely during its useful life. However, the purchaser or user of Flowserve products should be aware that Flowserve products might be used in numerous applications under a wide variety of industrial service conditions. Although Flowserve can (and often does) provide general guidelines, it cannot provide specific data and warnings for all possible applications. The purchaser/user must therefore assume the ultimate responsibility for the proper sizing and selection, installation, operation, and maintenance of Flowserve products. The purchaser/user should read and understand the Installation Operation Maintenance (IOM) instructions included with the product, and train its employees and contractors in the safe use of Flowserve products in connection with the specific application.

While the information and specifications contained in this literature are believed to be accurate, they are supplied for informative purposes only and should not be considered certified or as a guarantee of satisfactory results by reliance thereon. Nothing contained herein is to be construed as a warranty or guarantee, express or implied, regarding any matter with respect to this product. Because Flowserve is continually improving and upgrading its product design, the specifications, dimensions and information contained herein are subject to change without notice. Should any question arise concerning these provisions, the purchaser/user should contact Flowserve Corporation at any one of its worldwide operations or offices.

For more information about Flowserve Corporation, contact www.flowserve.com or call USA 1 800 225 6989.

FLOWSERVE CORPORATION
FLOW CONTROL DIVISION
 1978 Foreman Drive
 Cookeville, Tennessee 38501 USA
 Phone: 931 432 4021
 Facsimile: 931 432 5518